

AVN S7000

In-dash Motorised 7" Wide Touchscreen Satellite Navigation, AM/FM Receiver, DVD Player

 User Manual



TABLE OF CONTENTS

Safety Informations	2
Features	4
Accessories	6
Unit Installation	7-12
Installation	7
Removal	9
Wiring Connection and Diagram	10
Disc Notes	13
Installing the N7000 Navibox	14-15
Unit View	16-24
Front Panel	16
Front Panel Display	19
Remote Control	21
Basic Operation	25
Touch Screen Operations	27-54
Touch Screen Calibrate	27
Main Menu	28
Radio Operations	29
DVD Operations	35
USB Operations	37
TV Operations	37
iPod Operations	40
AV IN Operations	43
Bluetooth Operations	44
System Setup	52
DVD Setup Menu	56-61
Setup Menu Operation	56
System Menu	57
Language Setup	58
Audio Setup	59
Video Setup	59
Speaker Setup	60
Digital Setup	61
Troubleshooting	62
Specifications	65

SAFETY INFORMATIONS

PLEASE READ COMPLETELY AND BECOME FAMILIAR WITH THE CONTENTS OF THIS MANUAL BEFORE INSTALLATION AND OPERATION OF THIS UNIT, AND KEEP IT CAREFULLY FOR FUTURE REFERENCE.

CAUTION: This unit is a class 1 laser product. The laser beam may cause hazardous radiation if exposure to laser system directly. Do not attempt to disassemble the unit personally.

This unit has been designed and manufactured to assure personal safety. Improper use can result in electric shock or fire hazard. The safeguards incorporated in this unit protect you if you observe the following procedures for installation, use and servicing. This unit doesn't contain any parts that can be repaired by the user. If the unit requires maintenance, contact an authorized service center.

Warnings

- Do not expose the product to rain, water or excessive moisture. This could cause electrical shorts, fire or other damage.
- This product is designed to operate with a 12 volt DC, negative ground battery system. Use the proper power supply.
- The monitor is operated automatically. Do not push in or pull out the monitor or try to reverse the monitor manually! Do not attempt to adjust the monitor angle upward or downward manually. It will cause damage to the Monitor Mechanism Structure.
- Do not impact the monitor with a hard object. It may cause permanent damage.
- Do ground all equipments and works in order to avoid causing damage to the unit by electrostatic discharges.
- The user who handles this product takes all necessary precautions to avoid ESD (Electro-Static Discharge) failures.
- Do not attempt to install or service your unit by yourself. Installation or servicing of the unit by persons without training and experience in electronic equipment and automotive accessories may be dangerous and could expose you to the risk of electric shock or other hazards.

Cautions:

- To reduce the risk of fire or electric shock, and annoying interference, use only the recommended accessories.
- While driving, keep the volume level low enough to be aware of road and traffic conditions.
- Parking in direct sunlight can produce very high temperatures inside your vehicle. Give the interior a chance to cool down before starting playback.

- Do not use any chemical solvent, cleaning agent or corrosive detergent to clean away dirt on the surface of the TFT monitor screen. It may cause irreversible damage.
- Small black and shiny dots inside the liquid crystal panel are normal for liquid crystal product.
- In extremely cold temperatures, the movement of the picture may be slow and the picture may be dark, but this is not a malfunction. The unit will work normally once reach its operating temperature.
- Do not use and store the unit in dusty, high temperature and high humidity environments.
- Do not use the unit immediately when you bring it from cold to warm place. Fast growing temperature, may cause moisture condensing which influence the unit for certain time.

Notes:

- This user's manual only for reference.
- Modifying rights are reserved.
- Modifications are subject to change without notice.

FEATURES

- ISO/1DIN Size
- DVD/DVDR/DVDRW/VCD/CD/CDR/CDRW/MP3 Compatible
7" WideScreen TFT/LCD Display
- Touch Screen Panel Control
Graphic User Interface
High Brightness: 400 cd/m²
- Resolution: 1440 x 234
- Color, Contrast, Brightness, Tint controls
- Fully Motorised Viewing Angle Adjustment
- Last Angle Memory for Panel
- Front Panel Display When the Monitor is Closed
Drop Down Detachable Front Panel for Invisible DVD Insertion Slot
Slim Type Car DVD Slotin Mechanism
- Digital & Mechanical AntiShock with ESP Memory
- BuiltIn Dolby Digital Decoder
- BuiltIn MP4 Decoder
- Last Position DVD Memory
- OSD (On Screen Display)
- NTSC/PAL Auto / Selectable

- Full Function Remote Control
AM/FM PLL Synthesizer Tuner with 30 Memory Presets
- RDS Function (FM)
- Auto Store Preset Scan
- Preset EQ (POP CLASSIC ROCK JAZZ USER)
- Bass/Treble/Fader/Balance Controls
- Encoder Volume Control
- Extending Amplifier Control (AMP REM)
Auto Antenna Control (P. ANT)
- Telephone Mute Control (TEL MUTE)
- Brake Reminder System (BRAKE)
- Digital Clock
- Hi Power 50W x 4
- 4 RCA Audio Outputs
- 2 RCA SubWoofer Outputs
- 1 RCA Video Output
- 1 Set RCA Audio Video Input
- 1 RCA Rear View Camera Input (Camera not supplied)
BuiltIn Analogue TV Tuner (PAL B/G, I, D/K) (Antenna not supplied)
Mini USB port (Cable not supplied)
- iPod Input Connection (Cable supplied)
- Bluetooth Hands Free Function

ACCESSORIES

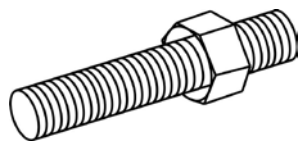

Bolt

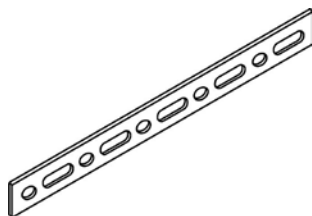

Steel Bar x 1



M5X5 Screws x 4

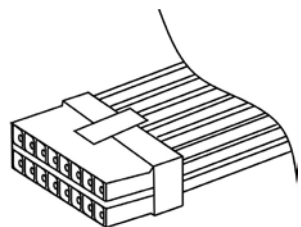

ISO Loom x 1

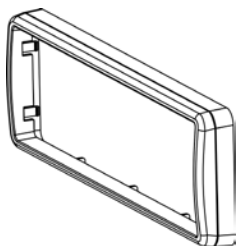

Trim Bezel x 1

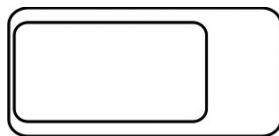

Remote Control x 1



User Manual x 1

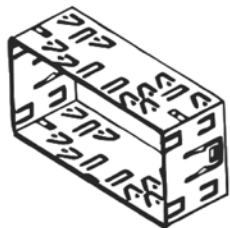

Mounting Sleeve x 1



Extraction Keys x 2

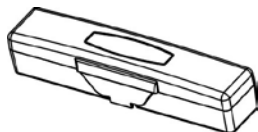

Detachable panel Box x 1



Nut M5 x 1



iPod Cable x 1

UNIT INSTALLATION

INSTALLATION

Please read all of the instructions before beginning the installation. It is strongly recommended to have your unit installed by a professional installation shop.

Tools and Supplies:

You will need these tools and supplies to install your unit:

- Torx type, flat-head and Philips screwdrivers
- Wire cutters and strippers
- Tools to remove existing radio (screwdriver, socket wrench set or other tools)
- Electrical tape
- Crimping tool
- Volt meter/test light
- Crimp connections
- 18 gauge wire for power connections
- 16~18 gauge speaker wire

Warnings:

Choose the mounting location where the unit will not interfere with the safe driving conditions.

Install the unit where it does not get in the driver's way and can not injure the passenger if there is a sudden stop, like an emergency stop.

Avoid installing the unit where it would be subject to high temperature, such as from direct sunlight, or from hot air, from the heater, or where it would be subject to dust, dirt or excessive vibration.

Cautions:

Before finally installing the unit, connect the wiring temporarily and make sure it is all connected up properly, the unit and the system work properly.

Use only the parts included with the unit to ensure proper installation. The use of unauthorized parts can cause malfunctions.

Consult with your nearest dealer if installation requires the drilling of holes or other modifications of the vehicle.

If installation angle exceeds 30 degrees from horizontal, the unit might not give its optimum performance.

SECURING THE UNIT TO THE MOUNTING BRACKET

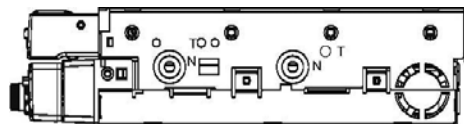

T=TOYATO
N=NISSAN

Installation Method

1. Install the front panel into the unit.

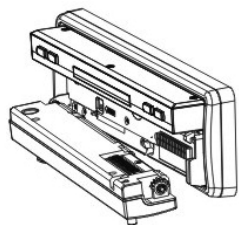

2. Bend the claws outward for tight fit, if necessary. Install the Mounting Box into the dashboard, tighten the unit in place.

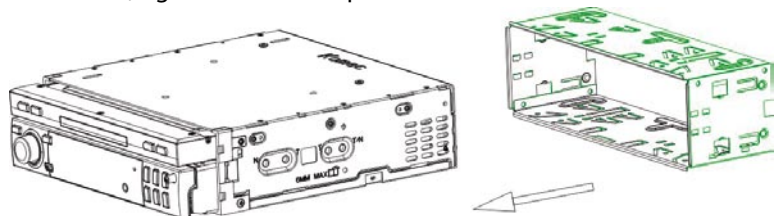

3. Install the Frame to the unit.

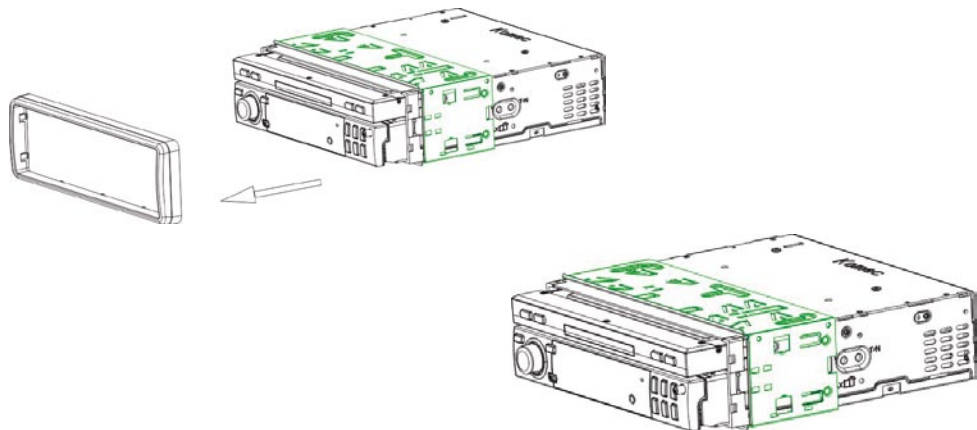

REMOVAL

1. Detach the front panel.

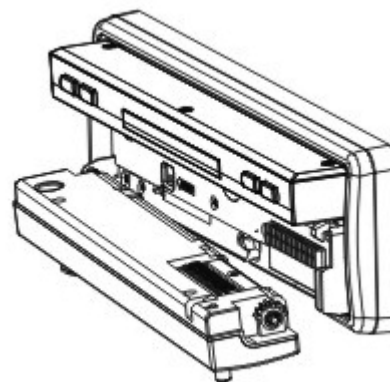

2. Insert the keys that supply to the unit at both sides of the unit (shown as illustrated) until pull the keys to make it possible to remove the unit from the dashboard.

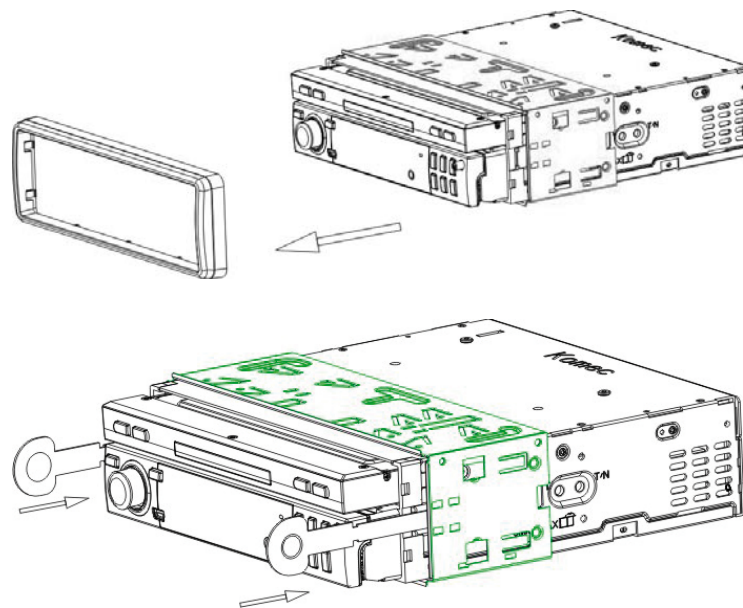

WIRING CONNECTION

Cautions:

- To prevent short circuits, remove the key from the ignition and disconnect the terminal of the battery.
- Make the proper input and output cable connections for each unit.
- Connect the wiring harness cables in the following order: ground wire, battery wire, ignition wire.
- Reconnect the terminal of the battery.
- Do not connect the yellow wire of this product directly to the battery terminal.
- Do remember to connect the red wire of this product to the ACC. of the ignition key switch. Failure to do may result in draining off the battery charge prematurely.
- If the fuse blows, first make sure that the cables have not caused a short circuit, then replace the old fuse with new one with the same rating.
- Do not let unconnected cables or terminals touch the metal on the car or other conductor.
- To prevent short circuits, do not remove the caps form unused terminals or from the ends of the unconnected cables.
- After the monitor unit is installed, check whether the brake lamps, blinkers, wiper, etc. on the vehicle are working properly. If not, please make sure they are proper installed.
- Insulate unconnected wires with vinyl tape or other similar material.

Disconnecting the Battery

To prevent a short circuit, be sure to turn off the ignition and remove the negative (-) battery cable prior to installation.

Reconnecting the Battery

When wiring is complete, reconnect the battery negative terminal.

Warning:

Be sure to use the correct type and amperage Fuse to avoid damaging the unit.

Fuse of the Battery wire in Main Unit: 15 amp;

Fuse of the ACC wire in Main Unit: 2 amp;

FUSE REPLACEMENT – WARNING!



Never replace any fuse with one of a higher value than the fuse supplied with your unit. Using a higher current rated fuse may cause damage to your unit and/or electrical wiring.

HAND BRAKE SAFETY CABLE – WARNING!



This device is equipped with a safety feature that prohibits viewing of moving pictures whilst the vehicle is in motion.

The Pink safety wire (Brake) on the systems own loom must be connected to the vehicles hand brake system (ground active).

WIRING DIAGRAM

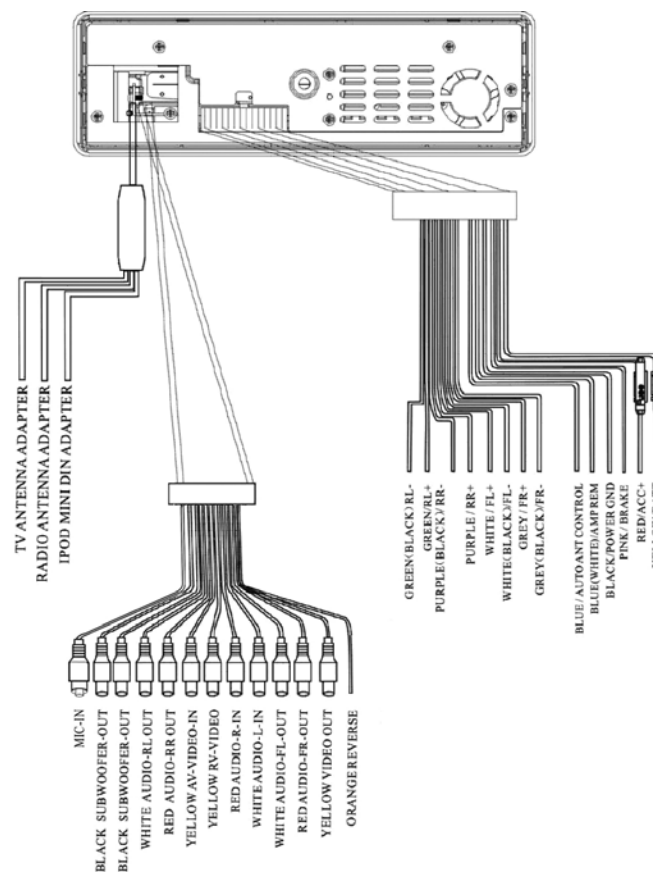

Notes:

- If the TV antenna is mounted near a radio antenna, reception quality may be affected during simultaneous reception of TV and Radio broadcasts.
- Please separate Battery Units before setting products to prevent from fire and electric shock. Mounting the antenna near to a radio antenna will result in noise. In this case, consult your dealer concerning mounting location.

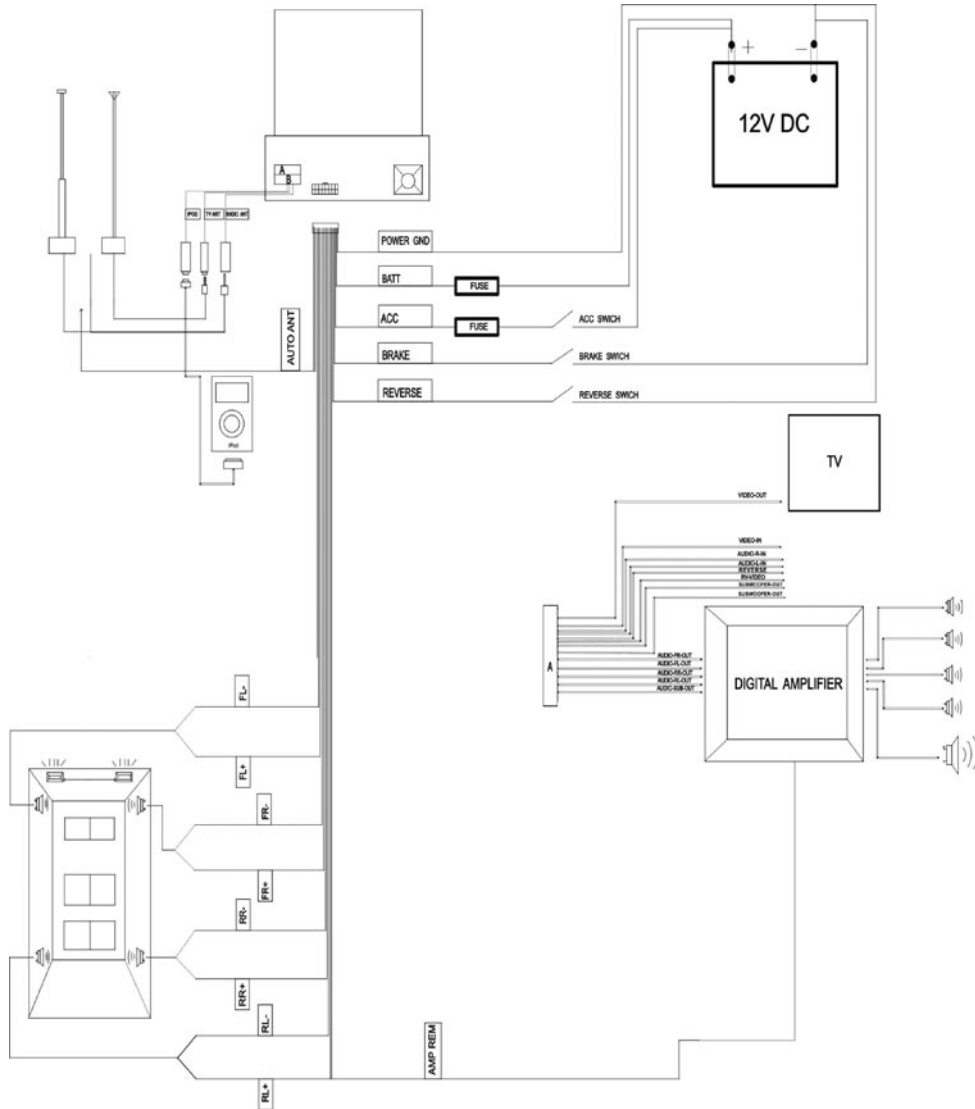

DISC NOTES

Disc formats supported by this player



Handling and Cleaning

Dirty, dusty, scratched or warped discs will cause misoperation.

Do not place stickers or make scratches on discs.

Do not warp discs.

A disc should always be kept in its case when not in use to prevent from damage.

Do not place discs in the following places:

1. Direct sunlight.
2. Dirty, dusty and damp areas.
3. High temperature places.
4. On the seats or dashboard.

Disc Cleaning

Use a dry soft cloth to wipe the surface. If the disc is quite dirty, use a soft cloth slightly moist with isopropyl (rubbing) alcohol. Never use solvent such as benzene, thinner or conventional record cleaners which may mar the surface of the disc.

Notes:

A disc may become somewhat scratched (although not enough to make it unusable) depending on your handling it in the condition of the usage environment. These scratches are not an indication of any problem with the player.

Repairing New Discs with Rough Spots

A new disc may have rough edges on its inside and outside edges. If a disc with rough edges is used, the proper setting will not be performed and the player will not play the disc. Therefore, remove the rough edges in advance by using a ballpoint pen or pencil. To remove the rough edges, press the side of the pen or pencil against the inside and outside edges of the disc.

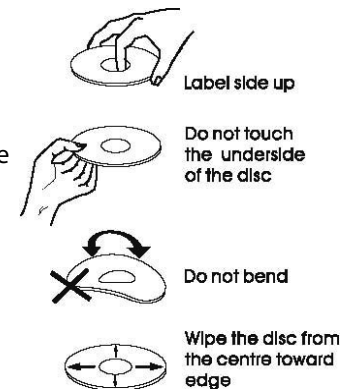
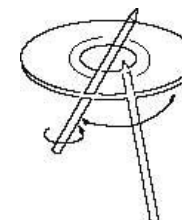

INSTALLING THE N7000 NAVI BOX

Components



Features

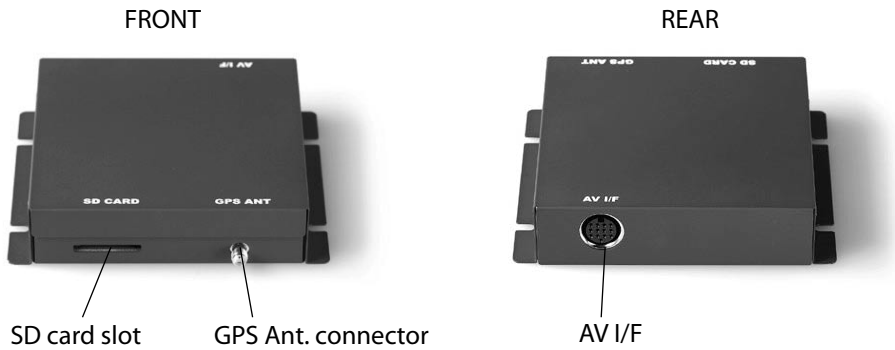

Mounting the Navi box

The Navi box needs to be mounted in a position where you have access to the SD card. This is critical if you wish to perform speed camera updates or map updates. There are a number of suitable places to mount the Navi box depending on your vehicle including the glove box, under the driver's or passengers seat or in the boot. It may also be possible to mount under the dash board in some cases. Remember that if you want to perform regular downloads the Navi box should be mounted so you have access to the SD card.



1. Installing the SD card



Connect the NAVIBOX to the AVNS 7000 head unit with the 13 pin din cable



Connect the GPS Ant. to the NAVIBOX

UNIT VIEW FRONT PANEL

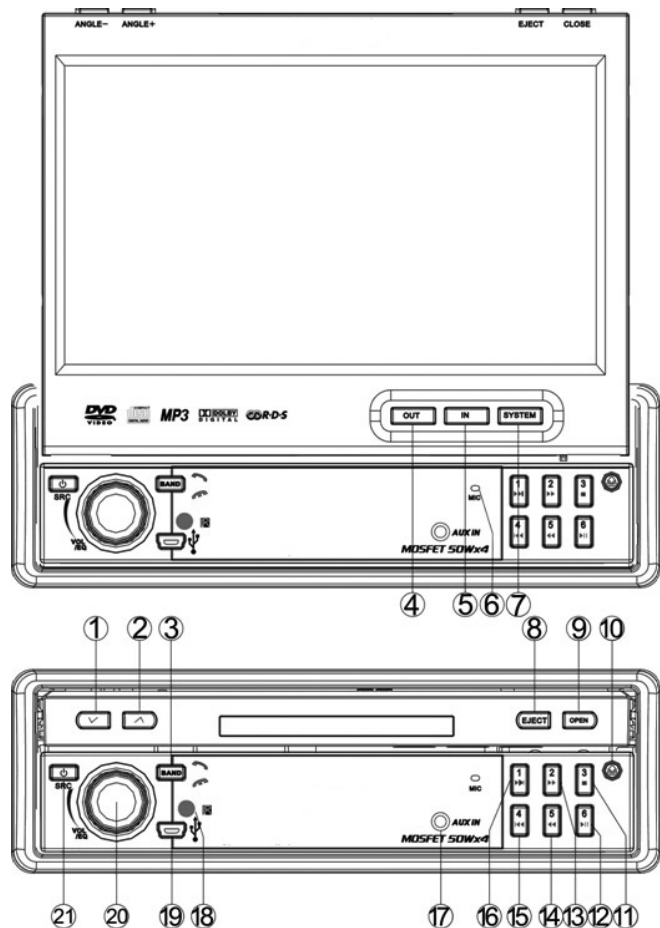

1. ANGLE -
2. ANGLE +
3. BAND/ CALL / TRANSFER
4. OUT
5. IN
6. MIC
7. SYSTEM
8. EJECT
9. OPEN/CLOSE
10. REL
11. STOP

12. PLAY / PAUSE
13. F.FWD
14. F.REV
15. PREVIOUS
16. NEXT
17. AUX IN
18. REMOTE
19. MINI USB
20. VOLUME / SEL / EQ
21. POWER / SOURCE

1. [ANGLE -] / 2. [ANGLE +]

Adjust the view angle of the monitor to choose the best displaying effect.

1- Continual angle adjustment

Hold on pressing the [ANGLE +] / [ANGLE -] buttons to adjust the angle of TFT monitor upward / downward by continual increasing / decreasing.

2- Single step angle adjustment

Press the [ANGLE +] / [ANGLE -] buttons to adjust the angle of TFT monitor upward / downward by singly increasing / decreasing.

3. [BAND]

In radio mode, press the [BAND] button to switch the wave band as following:
FM1-FM2-FM3-MW1-MW2

4. [OUT] / 5. [IN]

Press the [OUT] / [IN] buttons to move the monitor forward / backward by singly step
There are 4 steps to move the monitor forward / backward totally.

6. [MIC]

Microphone to talk during Bluetooth calls.

7. [SYSTEM]

Press to enter / exit the System Parameter Setup menu.

8. [EJECT]

When flip down the front panel, press to eject / load a disc.

9.[OPEN] / [CLOSE]

When unit power off, press the [OPEN] button to turn unit on and the monitor will spread out and turn around to the last angle position.

When unit power on, press to open / close the Monitor.

1- Open the TFT Monitor

Press the [OPEN] button, the monitor will spread out and turn around to the last angle position.

2- Close the TFT Monitor

Press the [CLOSE] button, the monitor will turn downward and completely retract in.

10. [REL]

Press to flip down the front panel.

11. [STOP]

Press to stop the playback

12. [▶||]

Press to pause playback when playing; press again to continue playing.

13. [F.FWD]

Press to select fast forward with different speed.

14. [F.REV]

Press to select fast reverse with different speed.

15. [PREVIOUS]

Press to skip to play the pervious track.

16. [NEXT]

Press to skip to play the next track.

17. [AUX IN]

Connect an external audio device to this jack to listen the sound through your car speakers (jack cable is not supplied).

18. [REMOTE]

Infrared Remote Receiver.

19. MINI USB

The unit will be switched to DVD Mode automatically when USB connected, and play the songs, pictures, videos in USB.

20. [VOL/SEL/EQ]

Rotate the button clockwise / anticlockwise to increase / decrease the volume.

Press the button to go in the Main menu.

Hold on pressing the button to enter the EQ setting as following:

USER – POP – CLASSIC – ROCK – JAZZ – USER

21. [POWER/SOURCE]

Press the [POWER/SOURCE] button to turn the unit ON;

Hold on pressing the button to turn the unit OFF.

When the unit in turned ON, press the [POWER/SOURCE] button to toggle between the different modes as following:

RADIO – DVD – USB – TV – IPOD – AV IN – AUX – BLUETOOTH – RADIO

NOTE

The unit could be switched to DVD Mode if disc inside;

The unit could be switched to USB Mode if Mini USB connected;

The unit could be switched to IPOD Mode if iPod connected;

FRONT PANEL DISPLAY

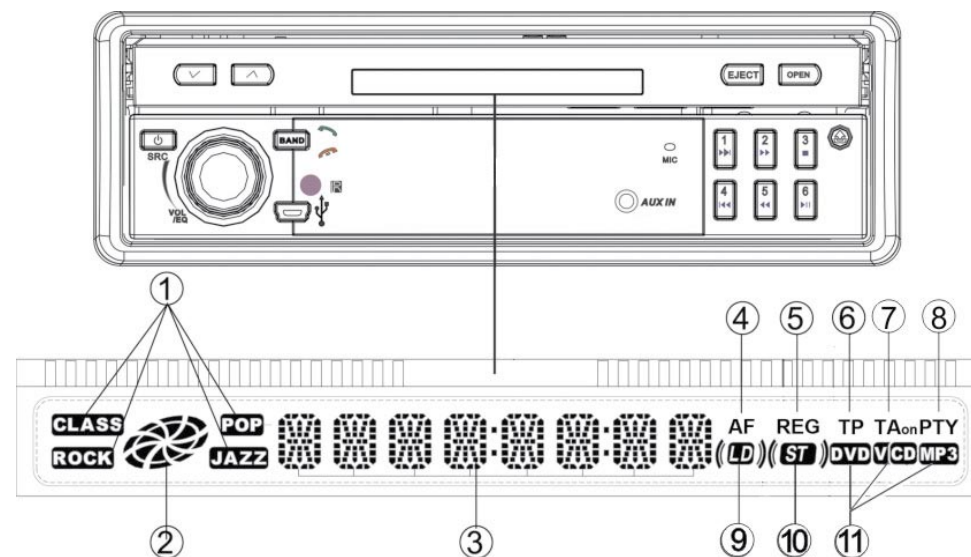

1. EQ Indicator:

It turns on to indicate the POP/CLASSIC/JAZZ/ROCK when corresponding setup. It turns off when user setup.

2. Disc Icon:

It rotates when playing disc under the DVD Mode.

3. Main Display Area:

Display the information such as working mode, characters, playback time & number of track, radio frequency, TV channel etc.

4. AF Icon: (Alternative Frequency)

It displays when the AF function is on (RDS On). Switch off this function to turn the RDS off.

5. REG Icon: (Regional)

It displays when the REGION function is on.

6. TP Icon: (Traffic Program)

It displays when the TP function is on.

7. TA Icon: (Traffic Announcement)

It displays when the TA function is on.

8. PTY Icon: (Program Type)

It displays when the PTY function is on.

9. LD Icon: (Loudness)

It displays when the LOUD function is on.

10. ST Icon: (Stereo)

It displays if listened station has stereo broadcast.

11. Disc Type Indicator:

It indicates the type of disc played (DVD, CD, VCD and MP3).

REMOTE CONTROL

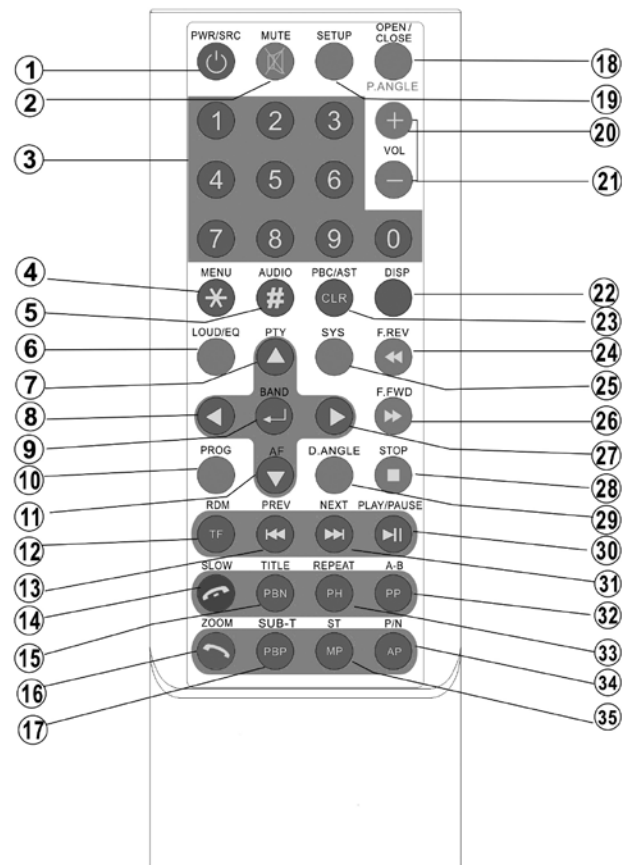

- | | | |
|-------------------------|------------------------|---------------------|
| 1. POWER/SOURCE | 13. PREVIOUS | 25. SYSTEM |
| 2. MUTE | 14. SLOW / END CALL | 26. F.FWD |
| 3. NUMBER BUTTONS | 15. TITLE / PBN | 27. RIGHT (Seek up) |
| 4. MENU / * | 16. ZOOM / CALL | 28. STOP |
| 5. AUDIO / # | 17. SUBTITLE / PBP | 29. D.ANGLE |
| 6. LOUD / EQ | 18. OPEN/CLOSE/P.ANGLE | 30. PLAY / PAUSE |
| 7. UP (Tune up)/PTY | 19. SETUP | 31. NEXT |
| 8. LEFT (Seek Down) | 20. VOLUME+ | 32. A-B / PP |
| 9. ENTER / BAND | 21. VOLUME- | 33. REPEAT / PH |
| 10. PROGRAM | 22. DISPLAY | 34. PAL / NTSC / AP |
| 11. DOWN (Tune Down)/AF | 23. PBC / AST / CLEAR | 35. STEREO / MP |
| 12. RANDOM / TRANSFER | 24. F.REV | |

1. [POWER/SOURCE]

Same functions as key on front panel.

2. [MUTE]

Press the [MUTE] button to switch off the sound; press it again to resume to the previous volume level.

3. [NUMBERS 0~9]

For 1~6, press these buttons to store the current radio station or recall the stored station under the Radio Mode.

For 0~9, press these buttons to select the tracks, and input the number code.

4. [MENU]

Press to return to the boot menu when playing DVD disc.

5. [AUDIO]

Press to select dialogue language when playing DVD disc.

Press to select left audio channel, right audio channel or stereo when playing VCD disc.

6. [LOUD/EQ]

Press to adjust the EQ setting as following:

USER – POP – CLASSIC – ROCK – JAZZ – USER

Hold on pressing to turn the LOUD function on / off.

7. [^] / [PTY] / 8. [<] / 11. [v] / [AF] / 27. [>] Direction Key

Under the menus:

Press the [^] / [v] buttons to move the cursor up / down to select item/track.

Press the [<] / [>] buttons to move the cursor left / right to select item/track.

Press [ENTER] to confirm

Under RADIO Mode:

Press the [<] / [>] buttons to switch the stored stations.

Hold on pressing the [<] / [>] buttons to fast seeking the next available channel by decreasing / increasing the tuning frequency; seeking will stop by pressing any button.

Press the [^] / [v] buttons to decrease / increase the frequency step by step.

Hold on pressing the [^] / [v] buttons to switch AF [^] or PTY [v].

9. [BAND/ENTER]

In RADIO mode, press the [BAND] button to switch the wave band as following:

FM1 – FM2 - FM3 - AM1- AM2 - FM1

In DVD mode, press the [ENTER] button to confirm selection in menus.

10. [PROGRAM]

Press to enter / exit the PROGRAM Function when playing the VCD, CD, MP3 disc.

12. [RANDOM/TRANSFER]

Press to turn RANDOM function on / off when playing CD / VCD disc (PBC OFF).

During a phone call, press to transfer the call between the unit and your cell phone.

13. [PREVIOUS]

Press to skip to play the pervious track.

14. [SLOW/END CALL]

Press to activate slow motion playback. (DVD Mode only)

Press to reject or hang up a call.

15. [TITLE/PBN]

Press to enter the title menu when playing DVD disc.

Under Bluetooth mode, press to display the next page of phonebook.

16. [ZOOM/CALL]

Press to magnify the picture display when play DVD, VCD disc.

Press to call a number or to receive a cell phone call.

17. [SUB-T/PBP]

Press to select the subtitle language when playing DVD disc.

Under Bluetooth mode, press to display the previous page of phonebook.

18. [OPEN/CLOSE/P.ANGLE]

Same functions as key on front panel.

19. [SETUP]

Press to enter the DVD SETUP menu.

20. [VOL+] / 21. [VOL-]

Press to increase / decrease the volume.

22. [DISPLAY]

Press to display current playback information when playing DVD disc.

23. [PBC/AST/CLEAR]

Press to select the PBC function on / off when playing VCD disc.

Hold on pressing to seek radio station automatically under RADIO Mode.

Press to cancel or clear the numbers you have input under Bluetooth Mode.

24. [F.REV]

Press to select fast reverse with different speed.

25. [SYSTEM]

Press to enter / exit the System Parameter Setup menu.

26. [F.FWD]

Press to select fast forward with different speed.

28. [STOP]

Press to stop the playback.

29. [ANGLE]

Press the [ANGLE] button during playback to select different viewing angles with interactive DVD media.

30. [PLAY/PAUSE]

Press to pause the playback when playing; press again to continue playing.

31. [NEXT]

Press to skip to play the next track.

32. [A-B/PHONE PAIR]

Press to setup A-B repeat playing.

Under Bluetooth mode, press this button to pair a Bluetooth cell phone with the unit

33. [REPEAT/PHONE]

Press to select the chapter / title / disc to repeat playing.

Press to connect/disconnect a paired Bluetooth cell phone.

34. [P/N/AUDIO PLAYER]

Press the button to switch the video output (PAL/NTSC) when playing DVD disc.

Press to connect/disconnect a paired Bluetooth audio device.

35. [STEREO/MUSIC PAIR]

Press to turn the stereo on / off under Radio Mode.

Under Bluetooth mode, press this button to pair a Bluetooth audio device with the unit

REPLACING THE BATTERY

1. If the remote control has no function or if the operating range reduced, replace the old battery with new one. Pull out the battery holder. Follow the arrow 1 slide it to the right toward the battery while at the same time pull the battery holder away from the remote control.
2. Place the new battery. Place the new lithium battery with the (+) side up.
3. Push the holder back. Using the finger to push in the holder back until the locking sound is heard.

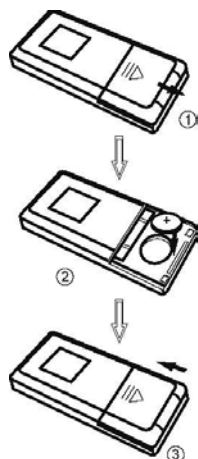

BASIC OPERATIONS

Startup

Press the [POWER/SOURCE] button on the panel or remote control to startup the power, the TFT monitor will spread out automatically and the system return to the working Mode when last turn off.

Turnoff

Hold on pressing the [POWER/SOURCE] button on the panel or remote control to turnoff the power, the TFT monitor will retract automatically.

NOTE

Close the ACC without turning off, the unit will turn off automatically; and the TFT monitor will retract within 10 seconds automatically to protect the TFT monitor. Start the ACC again, the unit will startup and return to the last working Mode automatically, but the monitor does not spread out.

Working Mode

When the unit in turned ON, press the [POWER/SOURCE] button to toggle between the different modes as following:

RADIO – DVD – USB – TV – IPOD – AV IN – AUX – BLUETOOTH – RADIO

NOTE

The unit could be switched to DVD Mode if disc inside;

The unit could be switched to USB Mode if Mini USB connected;

The unit could be switched to IPOD Mode if iPod connected;

Detachable Front Panel

The front panel is detachable.

Taking out the front panel; the unit will turn off and the TFT monitor will retract automatically after 5 minutes.

NOTE

This function is burglarproof for unit security.

Auto Antenna Control

Connect the auto antenna control wire AUTO_ANT (see Wiring Diagram); the antenna will lift when the unit startup; it will descend when the unit turnoff.

Brake Control

It is necessary to connect the Brake Control wire to the Hand-brake switch of the car. While driving, the TFT monitor will display the alarm picture (see as follows) in order to ensure the safety.

Under the Rear View Mode, the Brake Control function is no effective.



Protection of the TFT Monitor

During the movement of the TFT monitor, if it is halted by force, then the unit will begin self-protection to prevent from any damage on the motorized mechanical structure. Press the [OPEN] button or shut down the ACC and then restart, the TFT monitor will act as the follow list to recover; if not, then please consult with an authorized service center.

Halt	Self-protection	Press the [OPEN] button	Shut down the ACC and restart
While extending	Retraction	Extending	Retraction
While retraction	Stop at the halt place and retract after 3 seconds	Extending	Retraction
While turning upward	Turning downward and retraction	Extending	Turning downward and retraction
While turning downward	Stop at the halt place	Turning downward and retraction	Turning downward and retraction

TOUCH SCREEN OPERATIONS

TOUCH SCREEN CALIBRATE

When "Power Off", press the buttons 1, 2, 3, 4, 5, [BAND] of remote control to enter the CALIBRATE page:

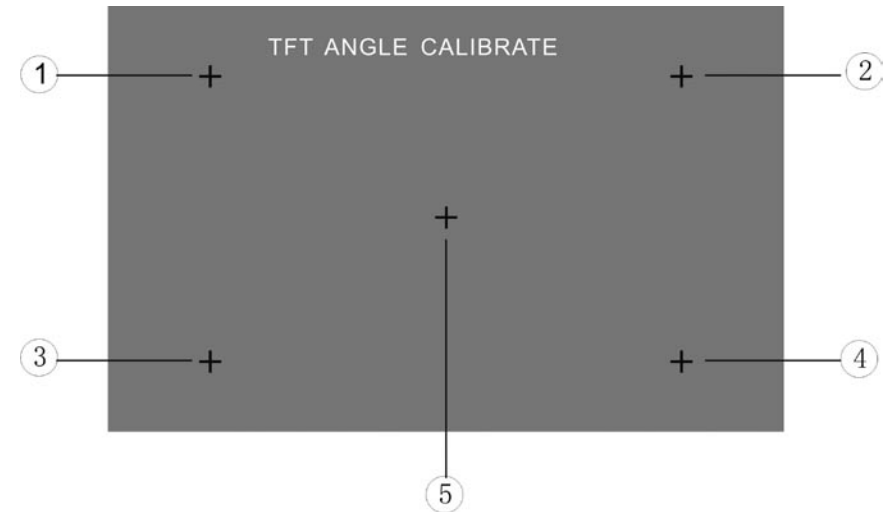

To touch the points from 1 to 5 until the points change to brighter by using a ballpoint pen or pencil.

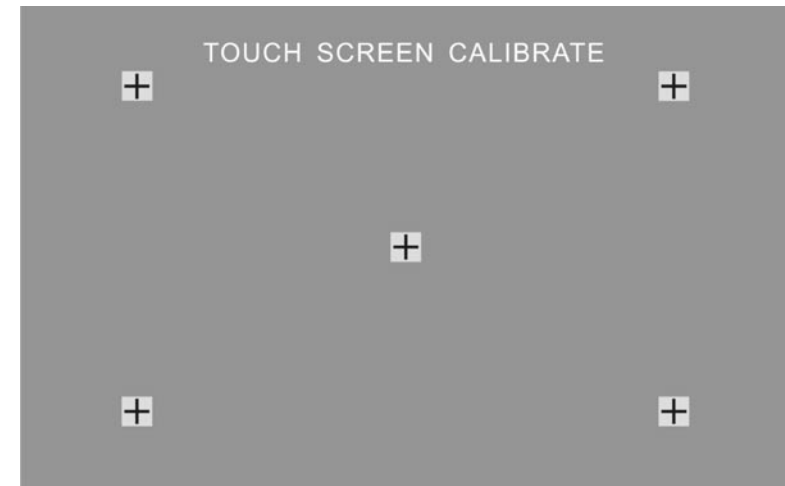

After all 5 points change to brighter, the unit would finish the CALIBRATE and will power off again. Then the Touch Screen calibration is complete.

MAIN MENU

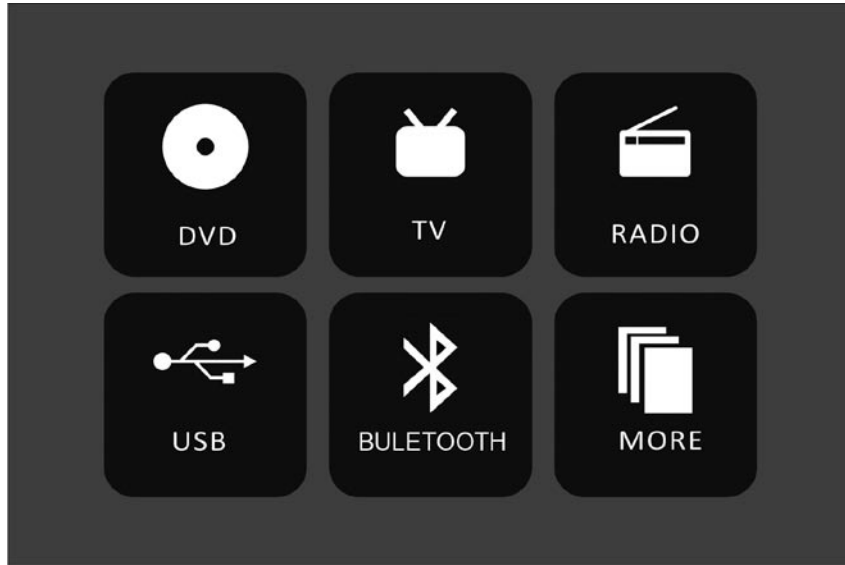

Touch the icon "MORE" to enter the 2nd page of main menu:

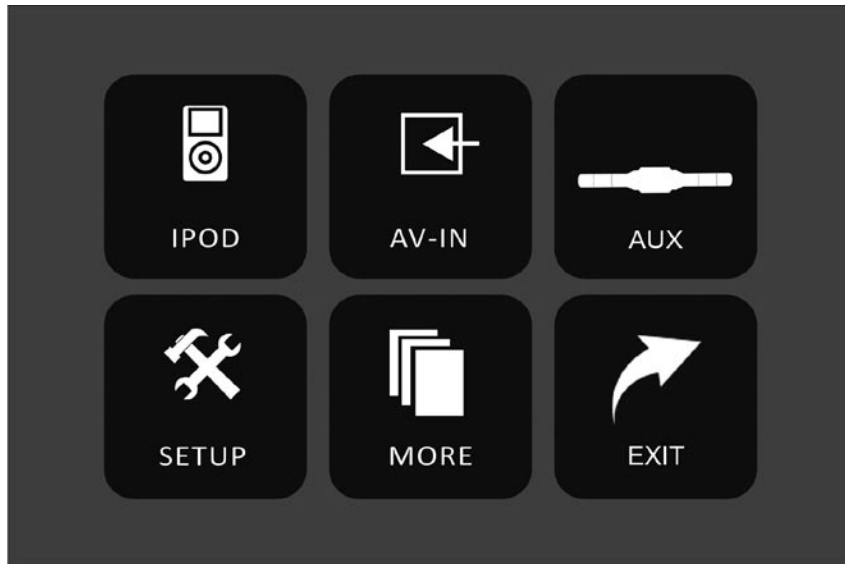

RADIO OPERATIONS

Touch the icon "RADIO" to enter the 1st operation page of RADIO Mode:

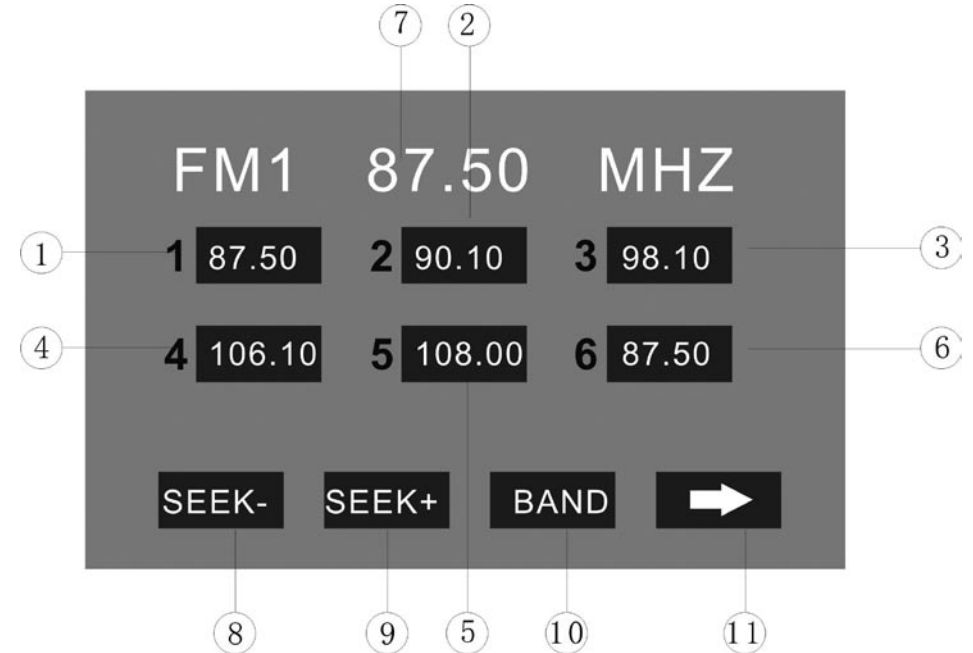

1~6. STORED CHANNEL

Manual Store Radio Station

Hold on touching the icon, you can store current radio frequency to the stored channel. For example, the current frequency is 98.5MHZ, by hold on touching the icon 1, you can store the radio station of 98.5MHZ to the channel 1.

After manual store radio station, the former stored stations will be instead. In each wave band, the number icons 1 to 6 represent the stored radio stations. Hold on pressing the number buttons 1~6 of remote control to perform same operation.

Recall a Preset Station

Touch the icon 1~6 to recall the corresponding stored station in M1~M6 channels. Press the number buttons 1~6 of remote control to perform same operation.

7. FREQUENCY

8. SEEK - / 9. SEEK +

Touch the icon to seek the next available channel by increasing / decreasing the tuning frequency.

Press any button to stop seeking.

Seeking will stop automatically when seek an available channel then play this station. The unit will stop on the beginning frequency if no available station after seeking one cycle.

Hold on pressing [>] / [<] buttons of remote control to perform same operation.

10. BAND

Touch the icon to switch the FM/AM wave band as following:

FM1 - FM2 - FM3 - AM1- AM2 - FM1

Press the [BAND] button of panel or remote control to perform same operation.

11. NEXT PAGE

Touch the icon to enter the 2nd page of RADIO Mode:



1. DOWN / 2. UP

Touch the icons to adjust the frequency downward / upward by step decreasing / increasing.

Hold on touching the icons has same function than [SEEK-] / [SEEK+].

Press the [<] / [>] buttons of remote control to perform same operation.

3. LOCAL: ON / OFF

Touch this icon to activate/deactivate the AF function.

When you are using the local searching function of LOCAL, you can only receive the radio station with strong enough signals and fine state.

4. NEXT PAGE

Touch the icon to enter the 3rd page of RADIO Mode:



1. ASM (Auto Store Mode)

Automatically seek and store stations

Hold on touching the icon to start seeking stations with the strongest signal from the lowest frequency point in the entire wave bands; press any button to stop seeking. After seeking, the former stored stations will be instead.

Store the received effective radio frequency to the six stored channels M1~M6.

1. The unit will play the stations one by one for few seconds; press any button to stop playing.
2. It is independent for FM & AM frequency. There are 3 wave bands of FM1-FM2-FM3 & 2 wave bands of AM1-AM2, each can store 6 radio stations, totally 30 stations can be stored.
3. The unit will stop on the beginning frequency if no available station after seeking one cycle.
4. Press the [AST] button of panel or hold on pressing the [PBC/AST] button of remote control to perform same operation.

2. AF (Alternative Frequency)

Touch this icon to activate the AF function. The detailed introduction refers to Radio Data System Operation (RDS) in next page.

3. MENU

Touch the icon to return the main menu.

4. NEXT PAGE

Touch the icon to return to the 1st page of RADIO Mode.

RADIO DATA SYSTEM OPERATION

Touch the icon of AF to enter the RDS Mode:

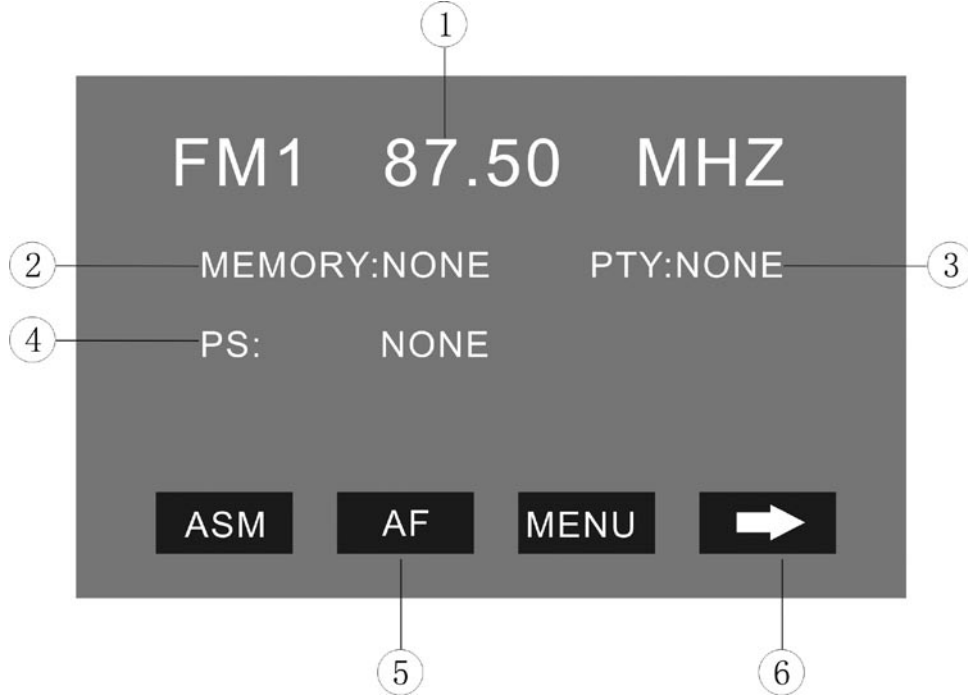

1. FREQUENCY

Frequency of listened station

2. MEMORY

Memory channel of listened station.

3. PTY (PROGRAM TYPE)

Program Type of listened station.

4. PS (PROGRAM SERVICE)

Station name and any information broadcasted by the station.

5. AF (ALTERNATIVE FREQUENCY)

Touch this icon or press the [AF] button to activate/deactivate the AF function.

When receiving conditions become bad, a station with better receiving conditions is automatically tuned into.

When searching an RDS station, the letters "AF" will flicker on the display; when receiving an RDS station, "AF" will be displayed without flickering on the LCD. If the reception becomes poor, the same station will be searched automatically for 60 seconds and PI SEARCH will be displayed on the LCD.

In AF mode, during the station search, press the [DISP] button to display following information: programme, programme name, type, frequency, time.

6. NEXT PAGE

Touch the icon to enter the 2nd page of RDS Mode.



1. TA (TRAFFIC ANNOUNCEMENT)

Touch the icon or hold on pressing the [TA] button to activate the Traffic Announcement mode. If you had a radio station before, the system will automatically switch to radio mode and broadcast the traffic announcement when the traffic announcement begins in every mode. If not, the system will automatically search a station in every mode and when the traffic announcement begins, it will switch to radio mode automatically.

In System setup, you can setup the initialization volume of TP, press the [^] / [v]

buttons to move the cursor to TA VOLUME, then press [<] / [>] buttons to adjust the volume. No matter how loud the volume is in the other mode, it will broadcast the traffic announcement in the same sound level. When listening to the traffic announcement, use the volume button to adjust the level, but if the volume is louder than the TA initialization volume level, it will not be possible to adjust the volume. When the signal of the Traffic-Program identification (TP) is bad, there will be a beep sound. The volume setup of the beep sound is the same as the TA initialization volume.

2. PTY (PROGRAM TYPE)

Touch the icon or press the [PTY] button to activate the PTY mode.

In PTY mode, press the AST button to scan and store stations with the 1-6 number buttons. Touch the [PTY] icon or hold on pressing the [^] button on panel or remote control to set up the programme, press the [<] / [>] buttons to choose the programme type and press the enter button to confirm.

Following options are available: NEWS, AFFAIRS, INFO, SPORT, EDUCATE, DRAMA, CULTURE, SCIENCE, VARIED, POP M, ROCK M, D.RMUSIC, LIGHT M, CLASSICS, OTHER M, WEATHER, FINANCE, CHILDREN, SOCIAL, RELIGION, PHONE IN, TRAVEL, LEISURE, JAZZ, COUNTRY, NATION M, OLDIES, FOLK M, DOCUMENT, TEST, ALARM. The default program is NEWS.

3. REG (REGIONAL)

Touch this icon or press to activate the REG function. Touch the icon again to deactivate REG function.

4. NEXT PAGE

Touch the icon to enter the 1st page of RDS Mode.

DVD OPERATIONS

Touch the icon "DVD" to enter the DVD Mode if disc inside.

The unit will switch to DVD Mode automatically if loading disc.

The unit will switch to RADIO Mode automatically if ejecting disc.

1st operation page of DVD Mode:

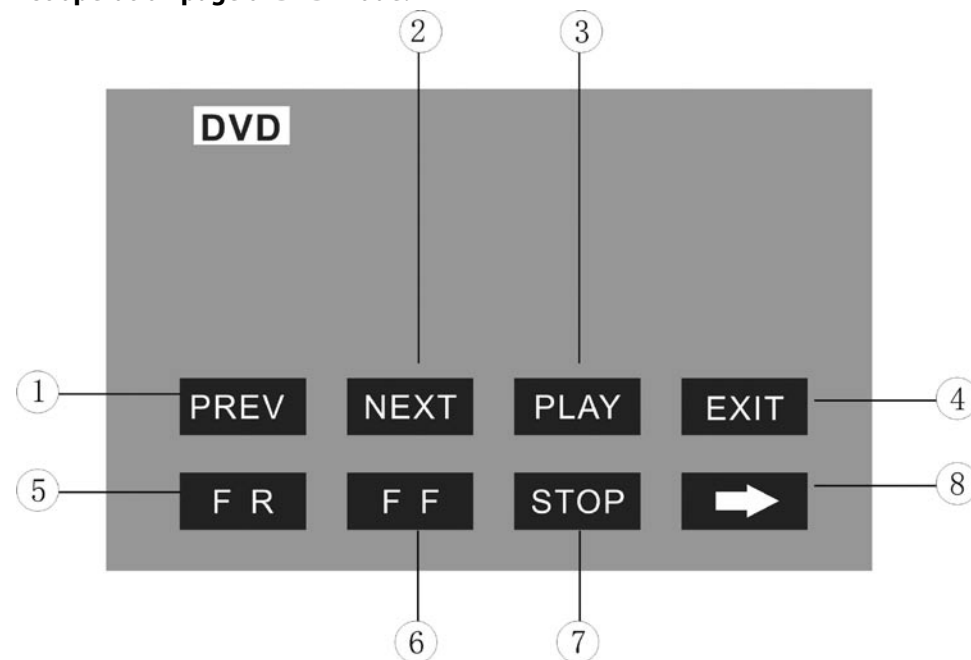

1. PREV / 2. NEXT

Touch the icon to go to the pervious / next chapter, track or song.

Press the [Previous] / [Next] buttons of remote control to perform same operation.

3. PLAY

Touch the icon to play or pause the disc.

Press the [PLAY/PAUSE] button of panel or remote control to perform the same operation.

4. EXIT

Touch the icon to exit the TOUCH ICONS display.

5. F.REV / 6. F.FWD

Touch the icon to select fast reverse / forward search. Touch the [PLAY] icon to resume to normal playback.

Press the [F.REV] / [F.FWD] buttons of remote control to perform the same operation.

7. STOP

During movie playback, touch the icon once; the DVD player memorizes the location where you stopped (touch the [PLAY] icon to resume playing from the memorized location). If you touch the icon twice, the playback will start from the beginning of the disc when you touch the [PLAY] icon.

Press the [STOP] button of remote control to perform the same operation.

8. NEXT PAGE

Touch the icon to enter the 2nd page of DVD Mode.

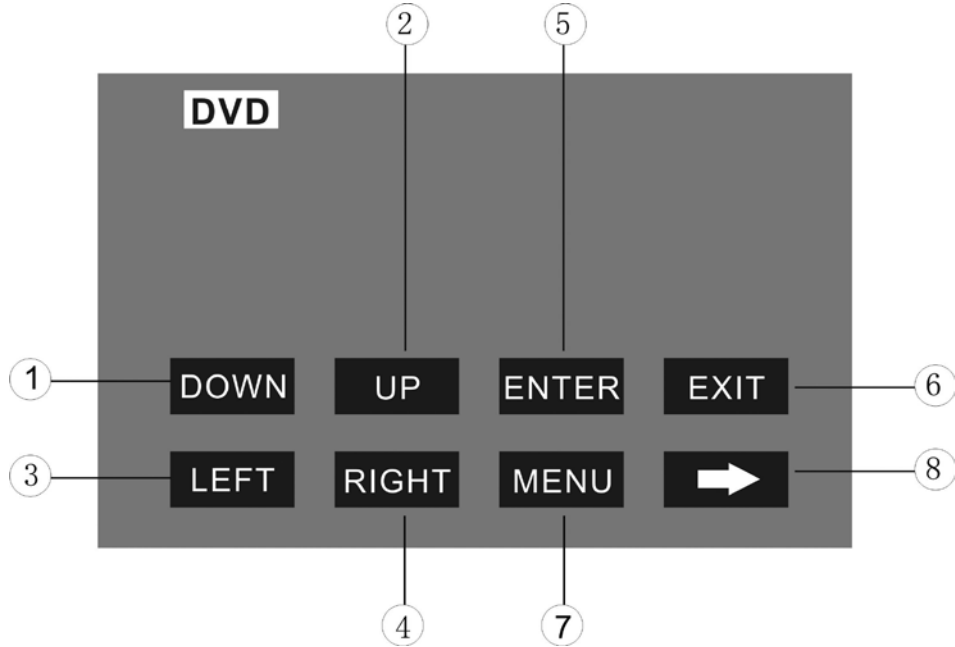

1~4. DOWN / UP / LEFT / RIGHT

Touch the direction icons (UP / DOWN / LEFT / RIGHT) to move the cursor to the selected item.

Press the direction buttons (UP / DOWN / LEFT / RIGHT) of remote control to perform same operation.

5. ENTER

Touch the icon to confirm the selection.

Press the [ENTER] button of remote control to perform same operation.

6. EXIT

Touch the icon to exit the TOUCH ICONS display.

7. MENU

Touch the icon to return the main menu.

8. NEXT PAGE

Touch the icon to enter the 1st page of DVD Mode.

USB OPERATIONS

Touch the icon "USB" to enter the USB Mode if USB connected.

The unit will switch to USB Mode automatically if connecting USB.

When disconnecting USB, the unit will switch to RADIO Mode automatically if there is no disc in the unit; and the unit will switch to DVD Mode automatically if there is a disc inside.

Under USB Mode, all operations are same than DVD operations.

Compatibility:

Due to the fast changing technology world, this unit may or may not be compatible to all the USB drives/devices of the market, especially USB drives/devices which require driver.

NOTE:

This unit is not compatible with portable Hard-Disk.

TV OPERATIONS

Touch the icon "TV" to enter the TV Mode:

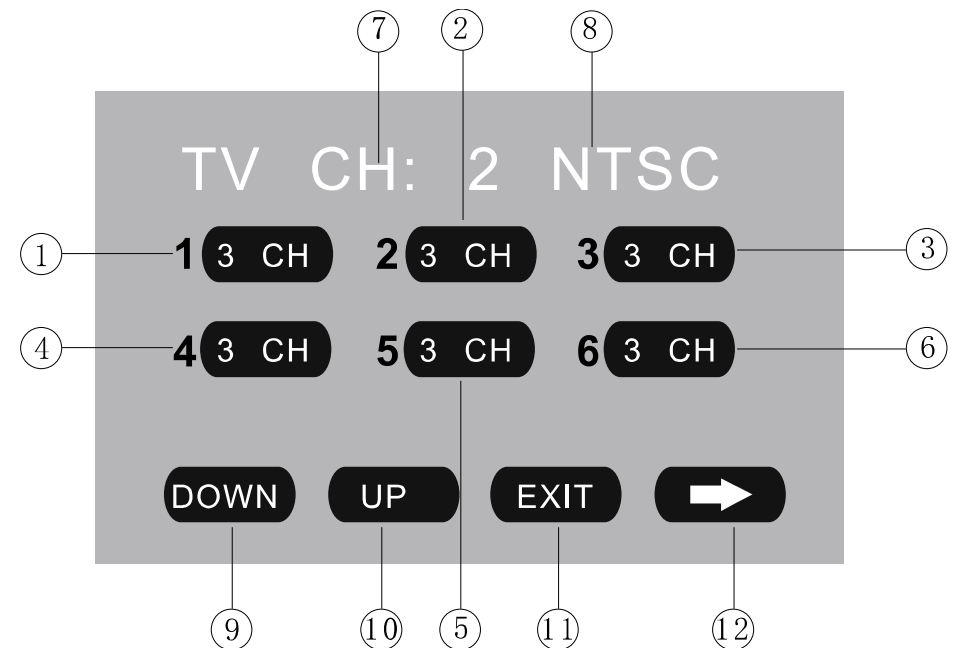

1~6. STORED CHANNEL

Manual Store TV Station

Hold on touching the icon, you can store current station to the stored channel. For example, the current station is 3 CH, by hold on touching the icon 1, you can store the radio station of 3 CH, to the channel 1.

After manual store TV station, the former stored stations will be instead.

The number icons 1 to 6 represent the stored stations.

Hold on pressing the number buttons 1~6 on the panel to perform same operation.

Recall a Preset Station

Touch the icon 1~6 to recall the corresponding stored station in M1~M6 channels.

Press the number buttons 1~6 on the panel to perform same operation.

7. TV CHANNEL

8. AUDIO FORMAT

9. DOWN / 10. UP

After [ASM] seeking, touch the icon to select the stations downward / upward.

Press the [^] / [v] buttons of remote control to perform same operation.

11. EXIT

Touch the icon to exit the TOUCH ICONS display.

12. NEXT PAGE

Touch the icon to enter the 2nd page of TV Mode:

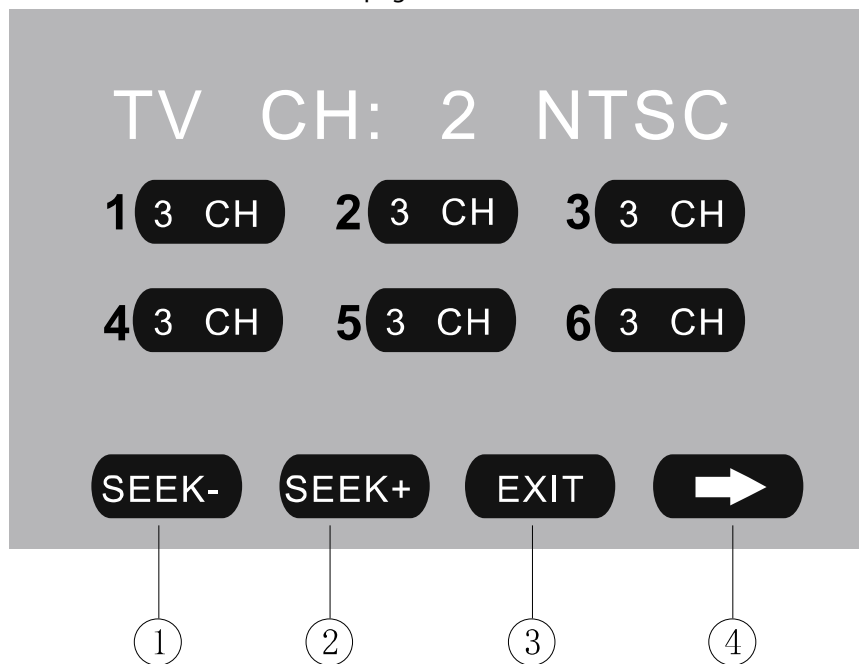

1. SEEK - / 2. SEEK +

Touch the icon to seek the next available channel by increasing / decreasing the tuning frequency.

Press any button to stop seeking.

Seeking will stop automatically when seek an available channel then play this station.

The unit will stop on the beginning frequency if no available station after seeking one cycle.

Hold on pressing [>] / [<] buttons of remote control to perform same operation.

3. EXIT

Touch the icon to exit the TOUCH ICONS display.

4. NEXT PAGE

Touch the icon to enter the 3rd page of TV Mode:

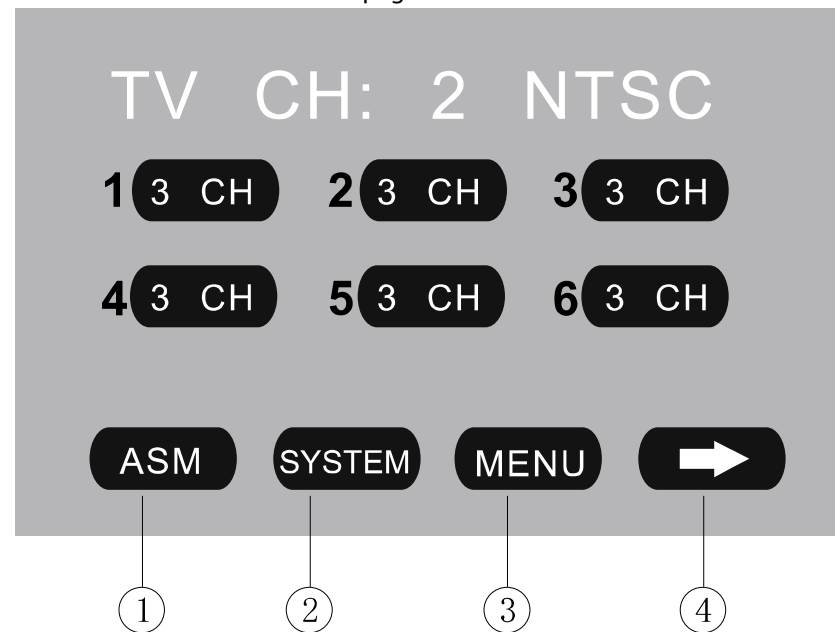

1. ASM (Auto Store Mode)

Automatically seek and store the stations.

Touch the icon to seek all stations with the strongest signal from the lowest frequency point; press any button to stop seeking. After seeking, the former stored stations will be instead.

Store the received effective TV stations to the six stored channels M1~M6.

The unit will stop on the beginning frequency if no available station after seeking one cycle.

Press the [PBC/AST] button of remote control to perform same operation.

2. SYSTEM

Touch the icon to switch the TV system as follow:

NTSC – PAL/BG – PAL/I – PAL/DK – NTSC

3. MENU

Touch the icon to return to main menu.

4. NEXT PAGE

Touch the icon to enter the 1st page of TV Mode.

* Select the Station Directly

Press the number buttons of remote control to select the station directly.

For example, press 2 to select station 2; press 1 & 2 to select station 12.

IPOD OPERATIONS

Touch the icon "IPOD" to enter the IPOD Mode if iPod connected.

The unit will switch to IPOD Mode automatically if connecting iPod.

The unit will switch to RADIO Mode automatically if disconnecting iPod.

Music Operation

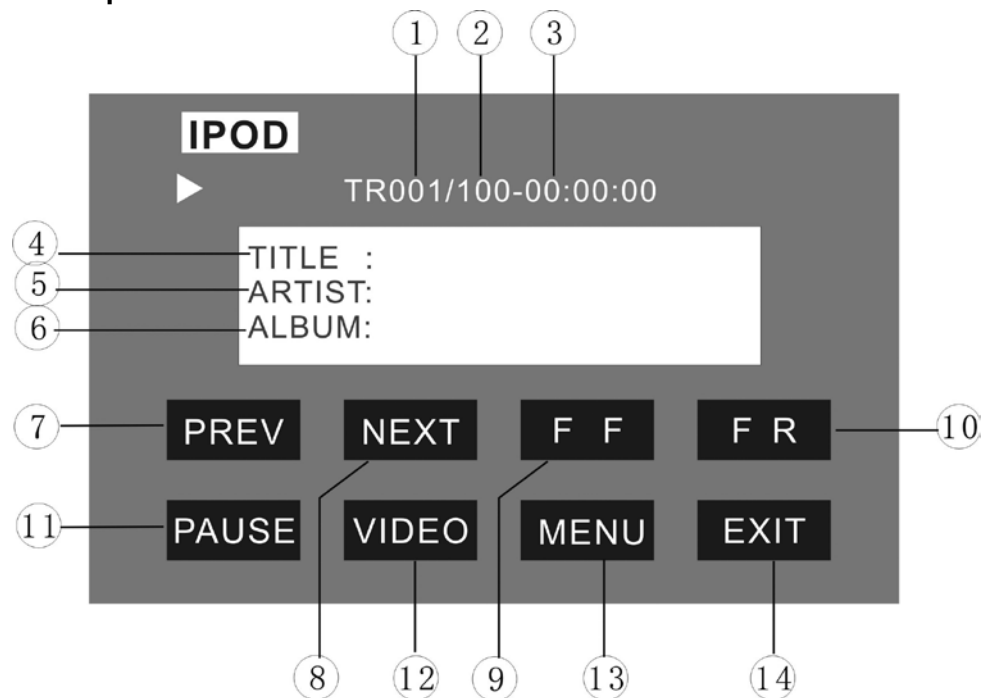

1. The Number of Playing Song

2. The Total Songs in Play List

3. The Playing Time

4. The Name of Playing Song

5. The Name of Artist

6. The Name of Album

7. PREV / 8. NEXT

Touch the icon to go to the previous / next chapter, track or song.

Press the [PREVIOUS] / [NEXT] buttons of remote control to perform same operation.

9. F.REV / 10. F.FWD

Touch the icon to select fast reverse / forward search. Touch the [PLAY] to resume to normal playback.

Press the [F.REV] / [F.FWD] buttons of remote control to perform the same operation.

11. PLAY / PAUSE

Touch the icon to play or pause the track.

Press the [PLAY/PAUSE] button of panel or remote control to perform the same operation.

12. VIDEO

Touch the icon to switch to the VIDEO operation.

13. MENU

Touch the icon to return the main menu.

14. EXIT

Touch the icon to exit the TOUCH ICONS display.

Video Operation

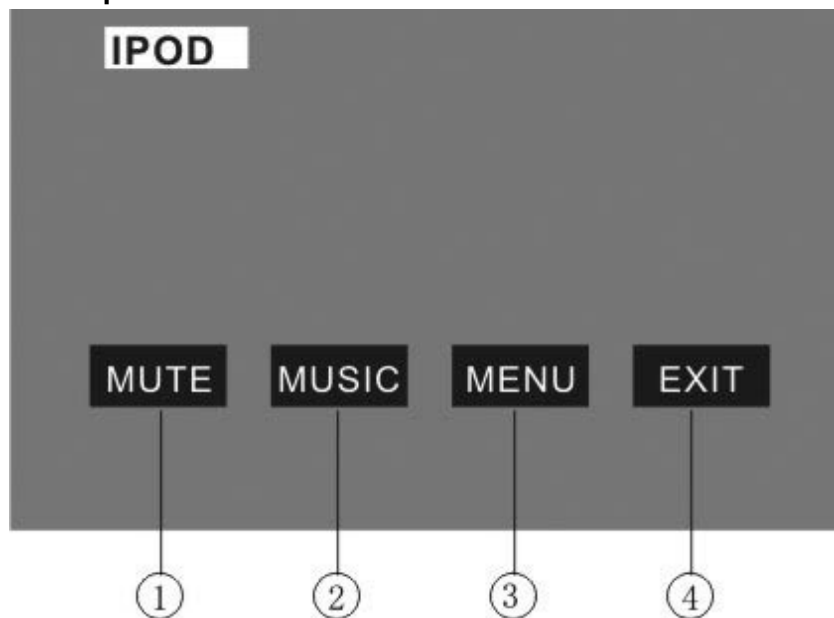

1. MUTE

Touch the icon to mute the sound; touch it again to resume to the previous volume level.

2. MUSIC

Touch the icon to switch to the MUSIC operation.

3. MENU

Touch the icon to return the main menu.

4. EXIT

Touch the icon to exit the TOUCH ICONS display.

AV IN OPERATIONS

Touch the icon "AV IN" to enter the AV IN Mode:

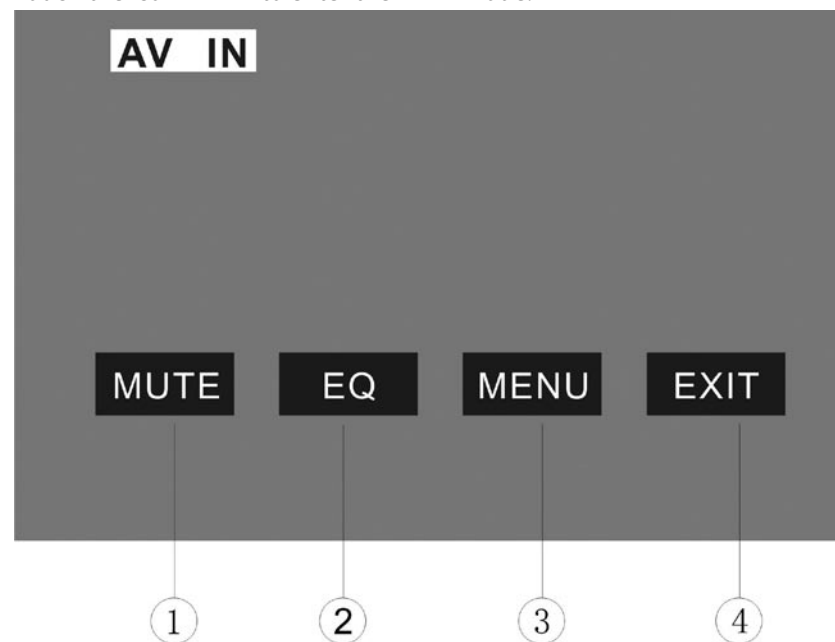

1. MUTE

Touch the icon to mute the sound; touch it again to resume to the previous volume level.

2. EQ

The user can adjust the audio output to his preference:

USER – POP – CLASSIC – ROCK – JAZZ – USER

3. MENU

Touch the icon to return the main menu.

4. EXIT

Touch the icon to exit the TOUCH ICONS display.

NOTE: There are 2 RCA Audio Inputs & 1 RCA Video Input for unit.

BLUETOOTH OPERATIONS

Touch the BLUETOOTH icon to enter the Bluetooth mode:

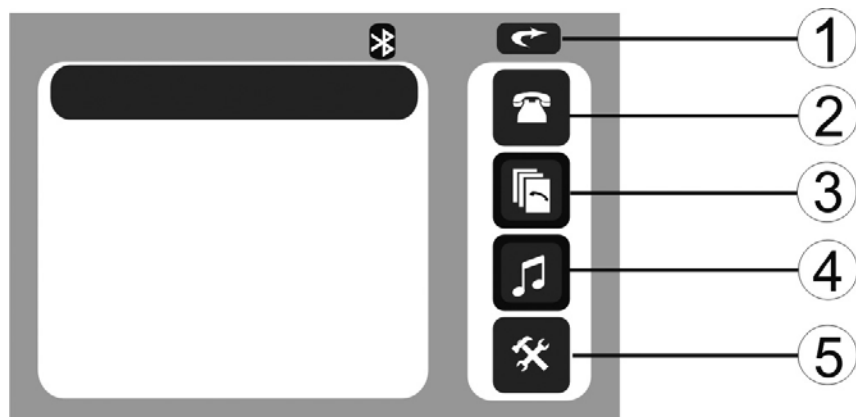

1. RETURN

Touch the icon to return the MAIN MENU.

Press the [DISPLAY] button of remote control to perform same operation.

2. PHONE CALL

Touch the icon to enter the phone calling.

3. PHONE BOOK

Touch the icon to enter the phone book lookup.

4. AUDIO

Touch the icon to enter the audio device operation.

5. SETTINGS

Touch the icon to enter the Bluetooth settings.

NOTE: Press the [BAND] button of remote control to toggle between the different working pages as following:

PHONE CALL – PHONE BOOK – AUDIO – SETTINGS – PHONE CALL

SETTINGS

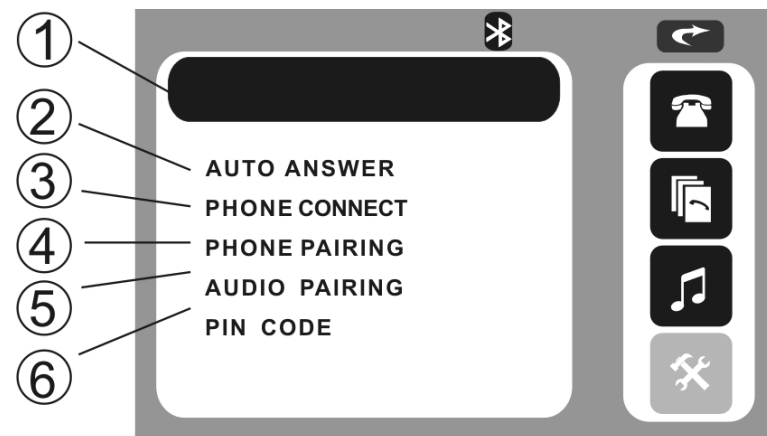

NOTE: Touch the icon 2~6, when item is changed to blue color, the item is selected. Touch it again to change the item to red color, the operation is active.

Press the [^] / [v] buttons of remote control to select the item (the item would be changed to blue color); press the [<] / [>] buttons of remote control to activate the operation (the item would be changed to red color).

1. INFORMATION DISPLAY

2. AUTO ANSWER

Touch the icon to select auto / manual answer when call is coming.

3. PHONE CONNECT

Touch the icon to select auto / manual phone connect when return back in the car.

4. PHONE PAIRING

Touch the icon, then see the below message on information display:

PHONE PAIR WAITING

Then set the phone to pair it with the unit.

Touch the icon again to cancel the pairing, and see the below message on information display:

PHONE PAIR FAIL

When pairing finished, set the phone to connect it with the unit, then you can see the phone name on information display.

Press the [PHONE PAIR] button of remote control under SETTINGS page to perform same operation.

5. AUDIO PAIRING

Touch the icon, then see the below message on information display:

AUDIO PAIR WAITING

Then set the audio device to pair it with the unit.

Touch the icon again to cancel the pairing, and see the below message on information display:

AUDIO PAIR FAIL

When pairing finished, set the audio device to connect it with the unit, then you can see the audio device name on information display.

Press the [MUSIC PAIR] button of remote control under SETTINGS page to perform same operation.

6. PIN CODE

You can change the PIN code by remote control. Press the [CLR] key of remote control to clear the PIN code, and input the new 4 digitals number, press the [SETUP] of remote control to save the new code.

NOTE: The unit can pair with totally 5 different devices including cell phones and audio players.

1. When you want to connect another paired cell phone with the unit, press the [PHONE] button of remote control to disconnect the current connecting cell phone; use the other cell phone to connect with the unit without pairing operations.

2. When you disconnected the current connecting cell phone, also you can press the [PHONE] button of remote control to connect the cell phone with the unit again.

3. When you want to connect another paired audio player with unit, press the [AUDIO PLAYER] button of remote control to disconnect the current connecting audio player; use the other audio player to connect with the unit without pairing operations.

4. When you disconnected the current connecting audio player, also you can press the [AUDIO PLAYER] button of remote control to connect the audio player with the unit again.

PHONE CALL

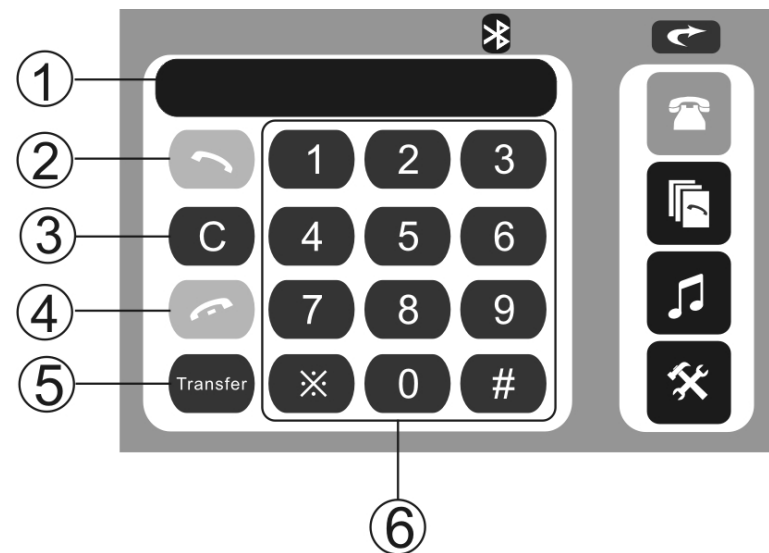

1. INFORMATION DISPLAY

2. CALL

Touch the icon to call a number or to receive a cell phone call.

Press the [CALL] button of remote control to perform same operation.

3. CLEAR

Touch the icon to cancel or clear the numbers you have input.

Press the [CLEAR] button of remote control to perform same operation.

4. END CALL

Touch the icon to reject or hang up a call.

Press the [END CALL] button of remote control to perform same operation.

5. TRANSFER

When talking the phone, touch the icon to transfer the call between the unit and your cell phone.

Press the [TRANSFER] button of remote control to perform same operation.

6. NUMBER KEYS

Touch the icon to enter a phone number.

Press the number buttons of remote control to perform same operation.

CALLING OUT

When call out, you will see the below information:

CALL OUT.*****

Then when talking, you will see the below information:

TALKING.*****

And end the call, you will see the below information:

END CALL.*****

CALLING IN

When call in, you will see the below image:



During conversation, you will see the below image:



And when end the call, you will see the below image:



PHONEBOOK

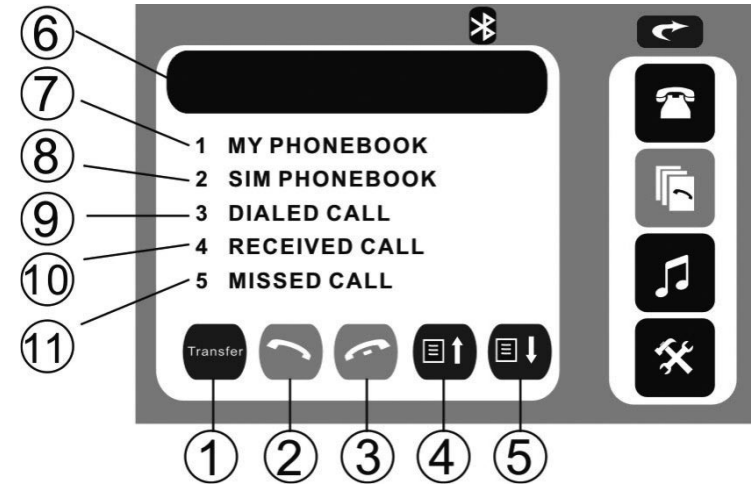

NOTE: Touch the icon 7~11, to select the item; touch it again to activate the operation. Press the [^] / [v] buttons of remote control to select the item (the item would be changed to blue colour); press the [<] / [>] buttons of remote control to activate the operation (the item would be changed to red colour).

1. TRANSFER

During conversation, touch the icon to transfer the call between the unit and your cell phone.

Press the [TRANSFER] button of remote control to perform same operation.

2. CALL

Touch the icon to call a number or to receive a cell phone call.

Press the [CALL] button of remote control to perform same operation.

3. END CALL

Touch the icon to reject or hang up a call.

Press the [END CALL] button of remote control to perform same operation.

4~5. PREVIOUS PAGE / NEXT PAGE

There are 5 numbers in each page, touch the icon to display previous / next page.

Press the [PBP] / [PBN] buttons of remote control to perform same operation.

6. INFORMATION DISPLAY

7. MY PHONEBOOK

The phonebook stored in the paired phone.

8. SIM PHONEBOOK

The Simbook stored in the paired phone.

9. DIALLED CALL

The dialled calls stored in the paired phone.

10. RECEIVED CALL

The received calls stored in the paired phone.

11. MISSED CALL

The missed calls stored in the paired phone.

Touch the icon to enter the phonebook, you will see the below image:

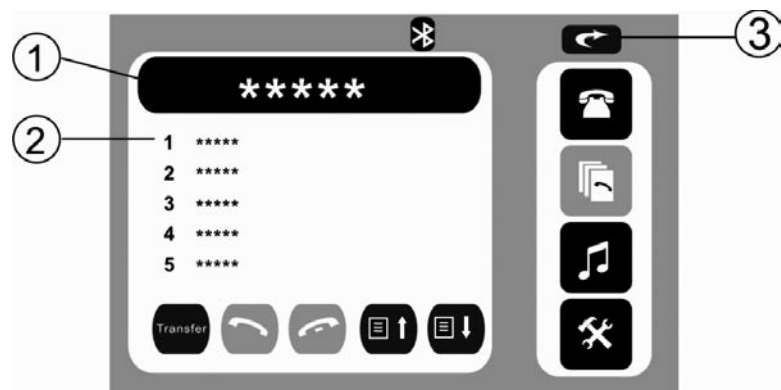

NOTE: Touch the icon 2 or press the [^] / [v] buttons of remote control to select item.

1. INFORMATION DISPLAY

You will see the phone number of the item in blue colour.

2. CURRENT PHONE NUMBER

If this number is stored, you will see the name; if not, you will see the phone number.

3. RETURN

Touch the icon to return to PHONE BOOK page.

Press the [DISPLAY] button of remote control to perform same operation.

AUDIO

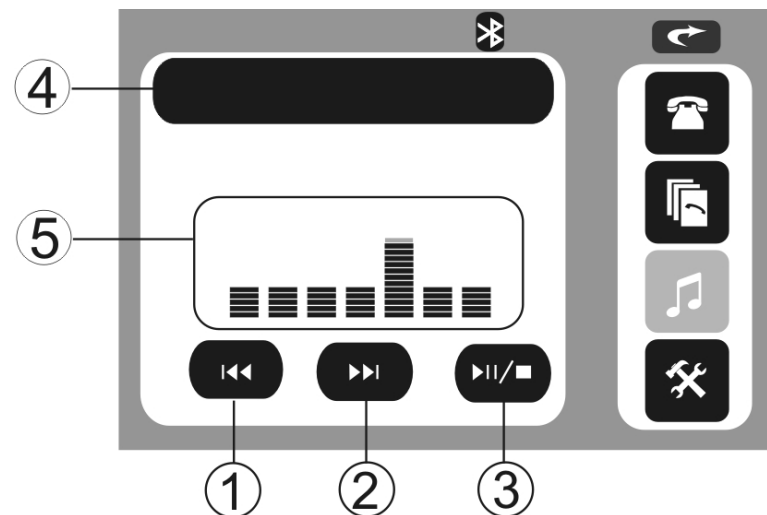

1. PREVIOUS

Touch the icon to select the previous track.

Press the [PREVIOUS] button of remote control to perform same operation.

2. NEXT

Touch the icon to select the next track.

Press the [NEXT] button of remote control to perform same operation.

3. PLAY / PAUSE

Touch the icon to pause playback when playing; touch it again to continue playing.

Press the [PLAY / PAUSE] button of remote control to perform same operation.

4. INFORMATION DISPLAY

It could display the name of connected audio device.

5. EQUALIZER DISPLAY

SYSTEM SETUP

Touch the icon "SETUP" or press the [SYSTEM] button of panel to enter the SETUP of system parameters:

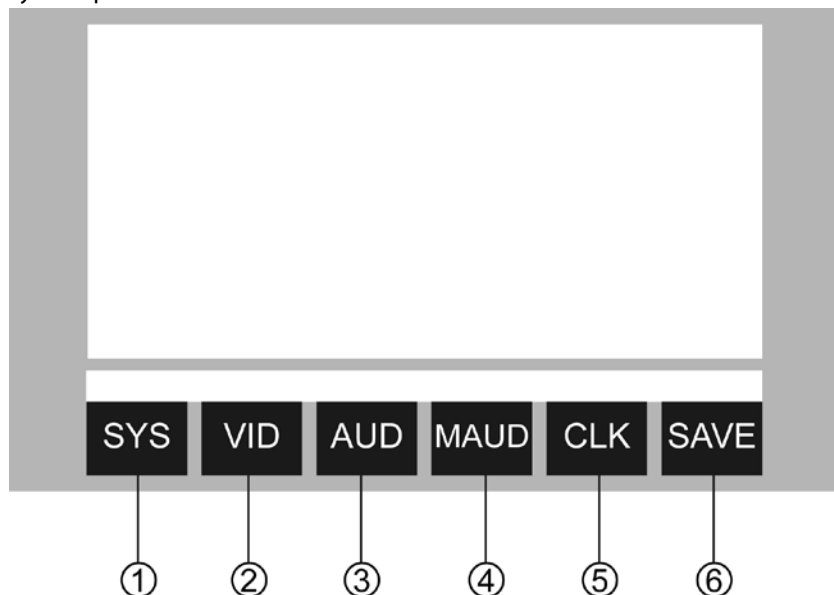

1. SYSTEM SETUP

2. VIDEO SETUP

3. AUDIO SETUP

4. MAUD SETUP (More Audio)

5. CLOCK SETUP

Touch the icon 1~5 to select the main menus directly.

6. SAVE SETTINGS

Touch the icon 6 to save all settings and exit SETUP.

SETUP MENU OPERATION

Press the [BAND] button of remote control to switch the main menus as following:

SYSTEM – VIDEO – AUDIO – MAUD – CLOCK – SYSTEM

Press the [^] / [v] buttons of remote control to select the item you want to change.

Press the [<] / [>] buttons of remote control to change the value of item.

Holding on pressing the [SYSTEM] button of panel to exit SETUP of system parameters.

SYSTEM SETUP

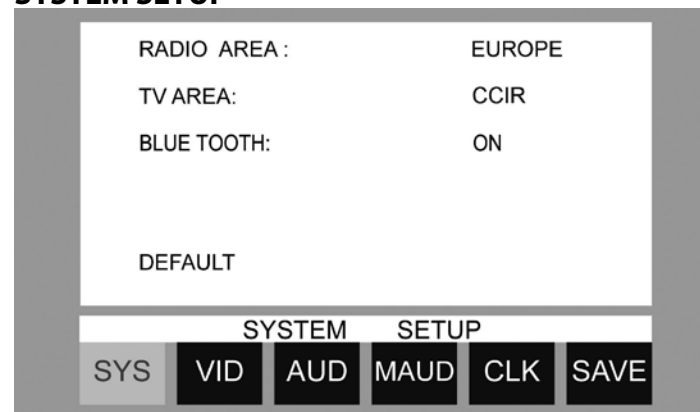

RADIO AREA: USA – JAPAN – OIRT – EUROPE – ASIA – USA

TV AREA: US – CCIR – IT – AUS – NZ – US

BLUETOOTH: OFF – ON – OFF

DEFAULT: The unit will restore all default settings of Sound Parameter, Picture Parameter & Tuner Parameter.

VIDEO SETUP

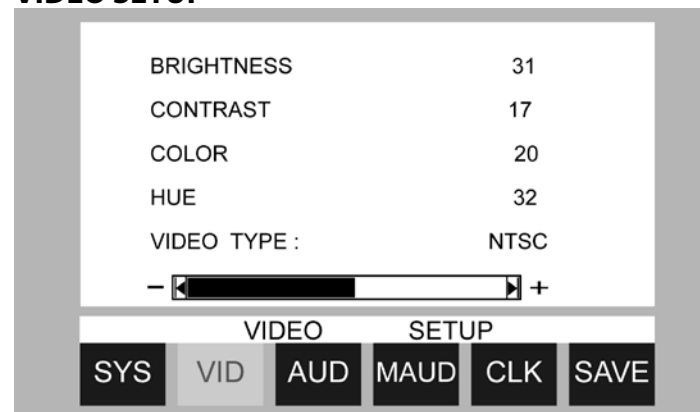

BRIGHTNESS: 0 ~ 64

CONTRAST: 0 ~ 64

COLOR: 0 ~ 64

HUE: 0 ~ 64

VIDEO TYPE: NTSC-PAL-AUTO-NTSC

AUDIO SETUP

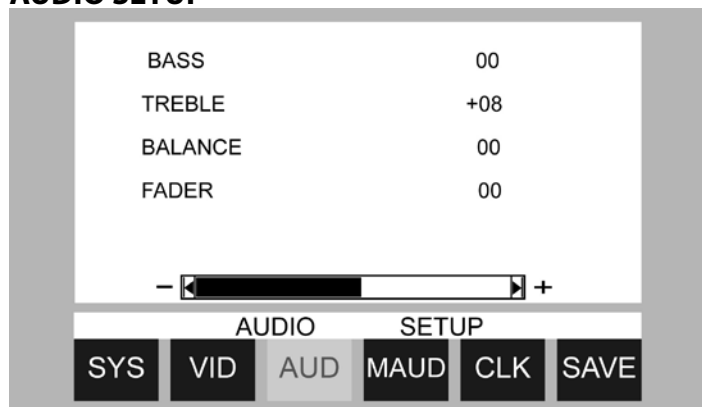

BASS: - 15 ~ + 15
TREBLE: - 15 ~ + 15
BALANCE: L 15 ~ R 15
FADER: F 15 ~ R 15

MAUD SETUP (MORE AUDIO SETUP)

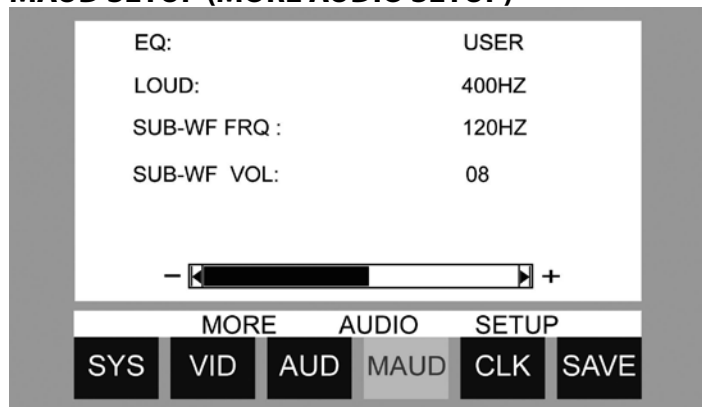

EQ: USER – POP – CLASSIC – ROCK – JAZZ – USER
LOUDNESS: OFF-400HZ-800HZ-2400HZ-OFF
SUB-WF FRQ: 80HZ-120HZ-160HZ-OFF
SUB-WF VOL: 0 -15

CLOCK SETUP

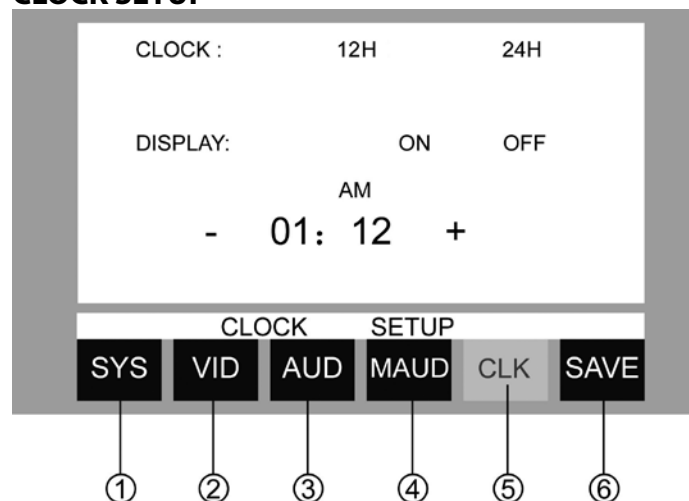

CLOCK: 12H / 24H
DISPLAY: ON / OFF
hour: 00 ~ 23
MINUTE: 00 ~ 59

DVD SETUP MENU

SETUP MENU OPERATION

Press the [SETUP] button of remote control to enter the DVD SETUP Menu.

Press the [<] / [>] buttons to switch the main menus as following:

SYSTEM – LANGUAGE – AUDIO – VIDEO – SPEAKER – DIGITAL

Press the [^] / [v] buttons to enter the submenus from main menus.

Press the [^] button on the top submenu or press the [v] button on the bottom of submenu to exit the submenus to main menus.

Press the [^] / [v] buttons to select the submenus as your need.

Press the [>] or [ENTER] buttons to enter the items of submenus.

Press the [<] button to exit the items of submenus.

Press the [^] / [v] buttons to select the item you want to change.

Press the [ENTER] button to confirm the item you have selected and exit to the submenus.

Press the [SETUP] button of remote control or press the [ENTER] button on the submenu EXIT SETUP to exit the DVD SETUP Menu and save all settings.

NOTE: Effective only in DVD, USB Mode.

SYSTEM MENU



TV SYSTEM

Following options are available for the TV Display:

NTSC

SCREEN SAVER

Select ON or OFF.

VIDEO

Following options are available for the TV Display:

INTERLACE-YUV TV-RGB P-SCAN YPBPR S-VIDEO

TV TYPE

Following options are available for the TV Display:

4 : 3 PS 4 : 3 LB 16 : 9

PASSWORD

Setup the password for Parental Ratings change. The default password is 0000.

RATING

Following options are available for the Parental Ratings:

1 KID SAFE 2 G 3 PG 4 PG 13

5 PG - R 6 R 7 NC - 17 8 ADULT

The Parental Ratings could be changed after the correct password input.

DEFAULT

The unit will restore all default settings by selecting this option.

LANGUAGE SETUP

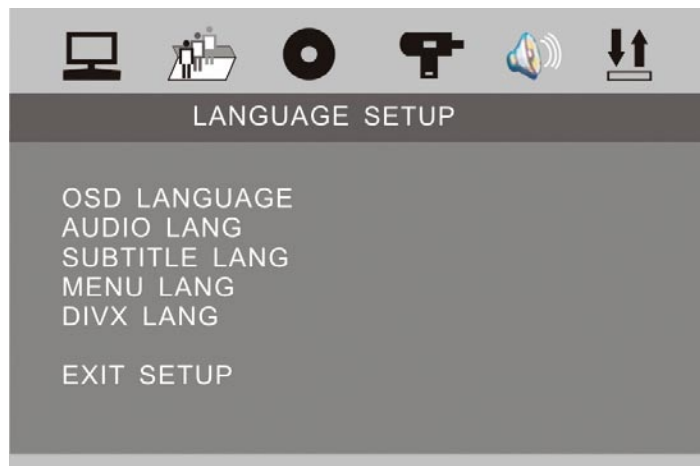

OSD LANGUAGE

Following options are available for the OSD LANGUAGE:

ENGLISH	GERMAN	SPANISH	FRENCH	PORTUGUESE
ITALIAN	RUSSIAN	DUTCH	SWEDISH	KOREAN
DANISH	NORWEGIAN	POLISH	HUNGARIAN	

AUDIO LANGUAGE

Following options are available for the AUDIO LANGUAGE:

ENGLISH	GERMAN	SPANISH	FRENCH	PORTUGUESE
ITALIAN	RUSSIAN	DUTCH	SWEDISH	KOREAN
DANISH	NORWEGIAN	POLISH	HUNGARIAN	

SUBTITLE LANGUAGE

Following options are available for the SUBTITLE LANGUAGE:

ENGLISH	GERMAN	SPANISH	FRENCH	PORTUGUESE
ITALIAN	RUSSIAN	DUTCH	SWEDISH	KOREAN
DANISH	NORWEGIAN	POLISH	HUNGARIAN	

MENU LANGUAGE

Following options are available for the MENU LANGUAGE:

ENGLISH	GERMAN	SPANISH	FRENCH	PORTUGUESE
ITALIAN	RUSSIAN	DUTCH	SWEDISH	KOREAN
DANISH	NORWEGIAN	POLISH	HUNGARIAN	

DIVX LANGUAGE

Following options are available for the DIVX LANGUAGE:

CENTRAL EU	WESTERN EU	KOREAN
------------	------------	--------

AUDIO SETUP



AUDIO OUT

Following options are available for the AUDIO OUT:

SPDIF / OFF SPDIF / RAW SPDIF / PCM

KEY

Following options are available for the KEY:

b -4 -2 0 +2 +4 #

VIDEO SETUP



BRIGHTNESS

Following options are available for the BRIGHTNESS:

0 2 4 6 8 10 12

CONTRAST

Following options are available for the CONTRAST:

0 2 4 6 8 10 12

HUE

Following options are available for the HUE:

-6 -4 -2 0 +2 +4 +6

SATURATION

Following options are available for the SATURATION:

0 2 4 6 8 10 12

SPEAKER SETUP



DOWNMIX

Following options are available for the DOWNMIX:

LT / RT Stereo VSS

BASS MODE

Following options are available for the BASS MODE:

ALL LG SPK ALL SM SPK MIXED SPK

DIGITAL SETUP

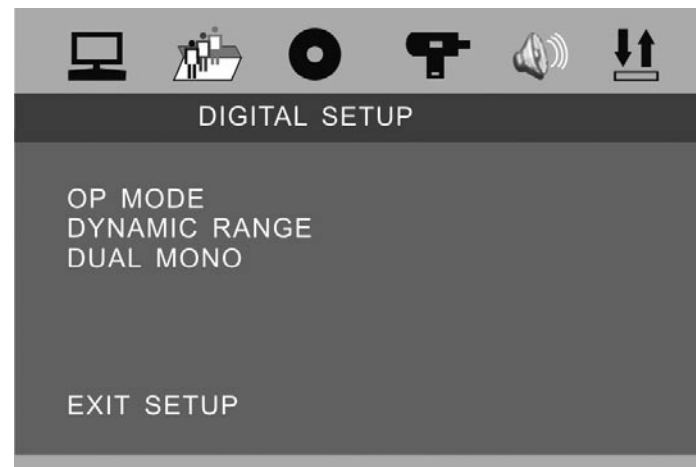

OP MODE

Following options are available for the OP MODE:

LINE OUT RF REMOD

DYNAMIC RANGE

Following options are available for the DYNAMIC RANGE:

FULL 6/8 4/8 2/8 OFF

DUAL MONO

Following options are available for the DUAL MONO:

STEREO MONO L MONO R MIX MONO

TROUBLESHOOTING

If any of problem persists after checking the below list, Please consult your nearest service dealer. Never attempt to disassemble and repair unit personally.

Problem	Cause	Corrective Action
GENERAL		
Unit will not power on	ACC Fuse blown Car battery fuse blown illegal operation	Install new fuse with correct rating Install new fuse with correct rating Press the RESET button located in the bottom right corner of the front panel
Remote control does not	Battery depleted Battery installed incorrectly	Replace battery with new one Remove battery and install correctly
No/low audio output	Improper audio output connection Volume set too low Speakers damaged Heavily biased volume balance Speakers wiring is in contact with metal Part or car	Check wiring and correct Increase volume level Review wiring diagram and check MUTE connection Replace speakers Adjust the channel balance to the center position Insulate all speaker wiring connections
Poor sound quality or distortion	Pirate disc is in use Speaker power rating not compatible with unit Speaker is shorted	Use original copy Connect proper speakers Check speaker contact
Tel-Mute malfunction	"MUTE" wire is grounded	Check that MUTE connection is not grounded and that it's properly insulated
Unit resets itself when engine is off	Incorrect connection between ACC and Positive battery wire	Check wiring and correct
TUNER		
Weak station searching	Auto antenna is not fully extended Auto antenna not properly connected LOCAL function is activated	Connect the auto antenna control cable properly Connect the auto antenna control cable properly Turn LOCAL function off

Problem	Cause	Corrective Action
TFT MONITOR		
Monitor does not open automatically	TFT Auto Open is turned of	Turn TFT Auto open on
No image	Incorrect connection to parking brake wire PARKING is activated and parking brake is not engaged	Check wiring and correct Stop vehicle in safe place and apply parking brake
Flashing image or interference appears on screen	DVD is not compatible with current TV system settings Image blurred, distorted, or dark	Change setup to accommodate disc
Prolonged image or improper height/width ratio display	Improper video signal connections Improper aspect ratio setup	Check wiring and correct Use correct aspect ratio setting
Monitor stops at incorrect position	Moving path is blocked	Press OPEN key to restart monitor movement
VCD		
Cannot insert disc	Disc already inside unit	Eject current disc and insert new one
Disc does not play back	Disc is warped or scratched Disc is dirty or wet Incompatible disc is used Disc rating exceeds Parental Lock rating limit Disc region code is not compatible with unit Disc is inserted upside down	Use disc in good condition Clean disc with soft cloth Use compatible disc Change parental Lock settings to lower restriction Use compatible disc Change Parental Lock settings to lower restriction Use disc with proper region cod Insert disc with label side up
Image blurred , distorted, or dark	Disc is illegally copied	Use original disc
PBC cannot be used during VCD playback	PBC is not available on the disc	
No repeat or searching while playing VCD	PBC is on	Turn PBC off

Problem	Cause	Corrective Action
MP3		
Interruption occurred during playback	Disc is dirty or scratched	Clean disc or replace
	File is damaged/bad recording	Recreate disc with good files
Incorrect playback message displayed	Message is longer than LCD can display	

Error Messages

Message Displayed	Cause	Corrective Action
Loading	Disc is being read	
No disc	Disc is dirty	Clean disc with soft cloth
	Disc is upside down	Insert disc with label side up
	Disc not present in loading compartment	Insert disc
Bad Disc	Disc is dirty	Clean disc with soft cloth
	Disc is upside down	Insert disc with label side up
Unknown disc	Disc format is not compatible with this unit	
Region Error	DVD is not compatible with region code of unit	
Error	illegal mechanism operation	Press EJECT key for 5 seconds to reset loading mechanism

SPECIFICATIONS

Front Power Output	Power	25W			AUDIO
	Load	4 Ohms			
	Frequency Response:	20Hz-20kHz			
	THD	≤30%(VOL MAX)			
Rear Power Output	Power	25W			
	Load	4 Ohms			
	Frequency Response:	20Hz-20kHz			
	THD	≤30%(VOL MAX)			
Equalizer Control Range	Frequencies	1KHz	100Hz	10KHz	
	Level (dB) POP EQ	2±2	7±2	12±2	
	Level (dB) CLASSIC EQ	2±2	7±2	8±2	
	Level (dB) ROCK EQ	2±2	9±2	12±2	
Signal to Noise Ratio:	≥80dB				
Line Input	Level	1.8V±0.2V			
	Impedance/Load	10K Ohms			
Line Output	Level	1.8V±0.2V			
	Impedance/Load	10K Ohms			
Subwoofer Output	Level	1.0V±0.2V			
	Impedance/Load	10K Ohms			
Video System:	PAL/NTSC (Manual switchable)				VIDEO
Video In/Out Level (CVBS):	1Vp-p(75Ω)±0.2V				
FM Tuner	Frequency Range:	87.5 - 108MHz			
	Sensitivity (-50dB):	≤26dB			
	Channel Selectivity:	22±6dB			
	Signal to Noise Ratio:	≥55dB			
	Frequency Response:	100Hz to 20kHz			
	Stereo Separation:	>20dB			
MW Tuner	Image Rejection:	≥60dB			
	Frequency Range:	522kHz - 1620kHz			
	Sensitivity (-20dB):	≤40dB			
	Signal to Noise Ratio:	≥45dB			
Compatible formats:	Frequency Response:	100Hz to 10kHz			
	Image Rejection:	≥60dB			
	CD/VCD/MP3/WMA/DVD/MPEG4				
Dynamic Range:	>85dB				PLAYER
Signal to Noise Ratio:	>85dB				
Electronic Skip Protection (ESP):	DVD-2s / CD-15s / MP3-50s / WMA-50s				
Screen Size:	7" (17,8cm) - 16/9				MONITOR
Screen Type:	TFT (Thin Film Transistor) Liquid Crystal Display (LCD)				
Pixel Size (mm):	0.15×0.216mm				
Resolution: 1440×234	Brightness: 400cd/m ²	Contrast: 300			
Response Time:	Rise Time: 15ms	Fall Time: 25ms			
Power Requirements:	Operating Voltage:	DC 14,4V (11 to 16V), Negative Ground			GENERAL
	Operating Temperature:	-10°C to +55°C			
Dimensions (WxHxD):	Installation Size (mm):	178×50×160			
	Panel Size (mm):	30×28.5×172			
	Weight:	2.5KG			

NOTE: Specifications and design are subject to change without notice.



Performance Products Ltd
Cleaver House, Sarus Court, Manor Park, Runcorn WA7 1UL UK
www.snooper.eu